

## Co-Interior Angles (A)

Find the co-interior angle measurements for the measured angles.

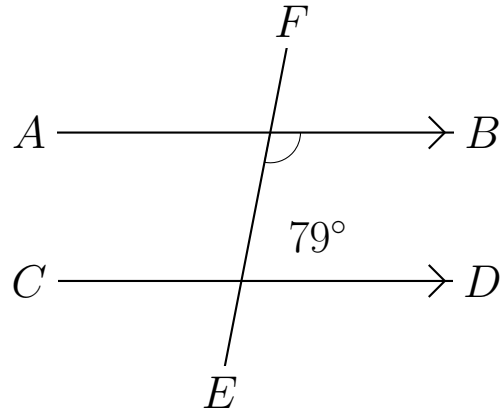
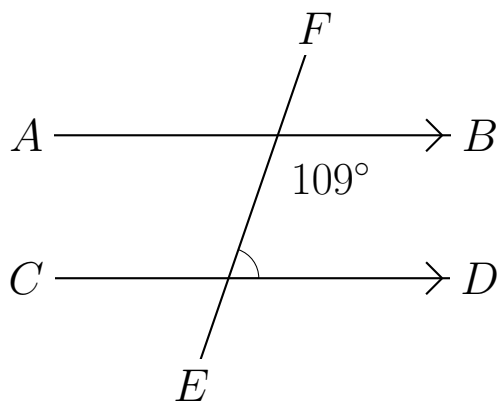
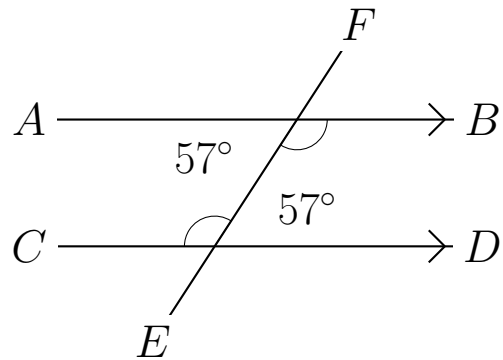
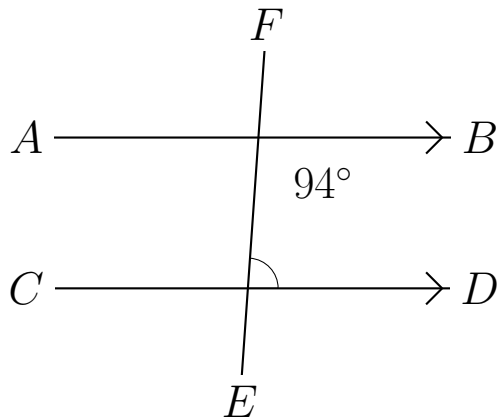
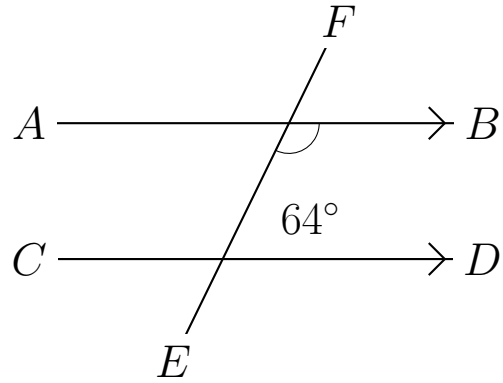
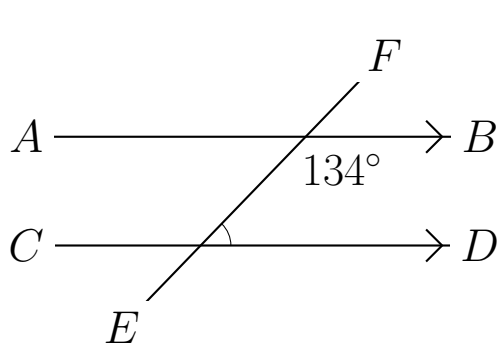

## Co-Interior Angles (A) Answers

Find the co-interior angle measurements for the measured angles.

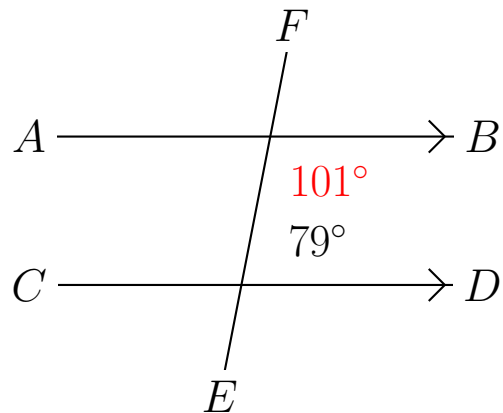
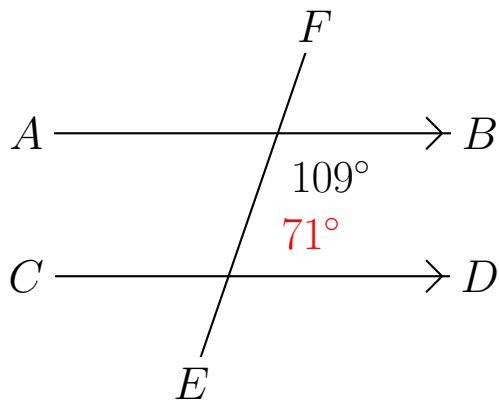
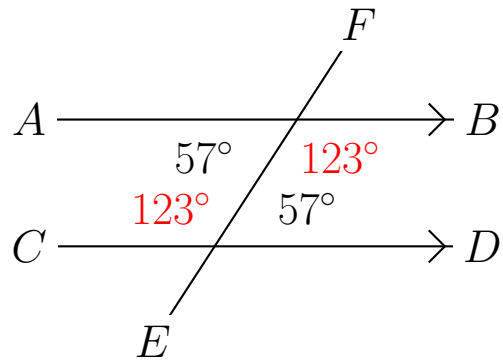
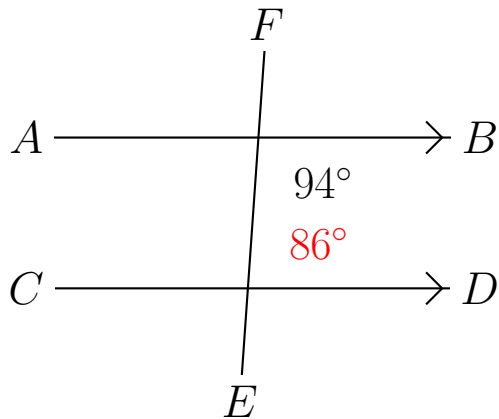
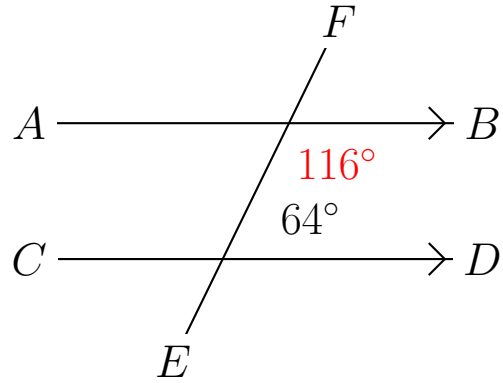
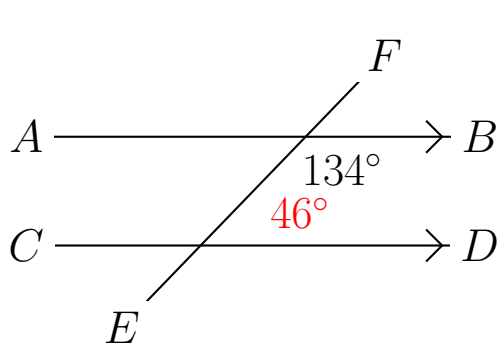

## Co-Interior Angles (B)

Find the co-interior angle measurements for the measured angles.

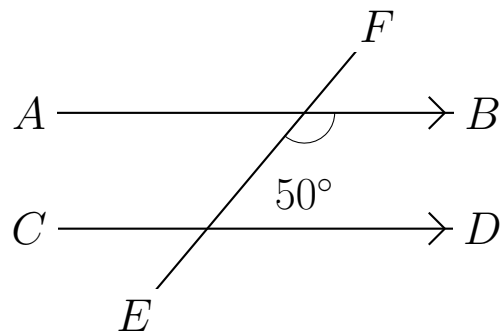
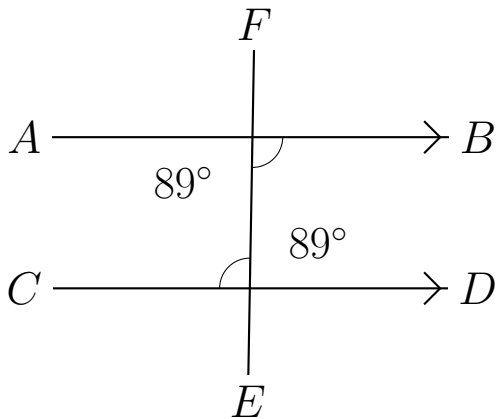
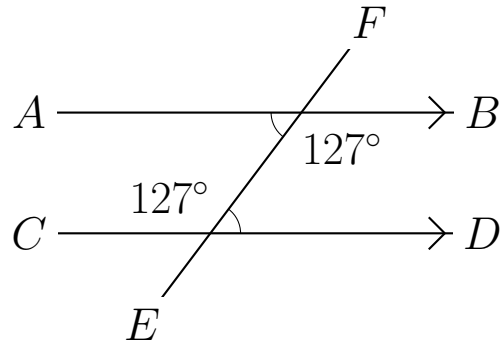
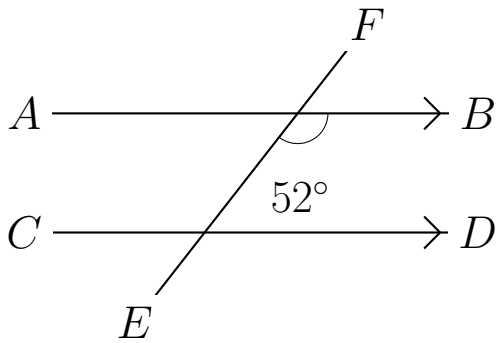
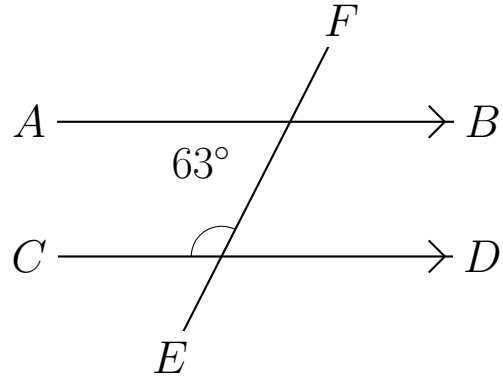
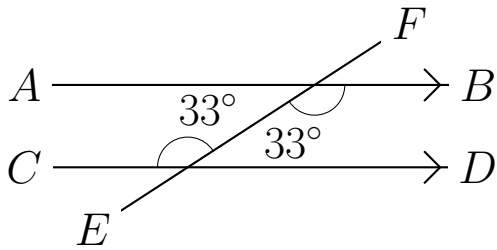

## Co-Interior Angles (B) Answers

Find the co-interior angle measurements for the measured angles.

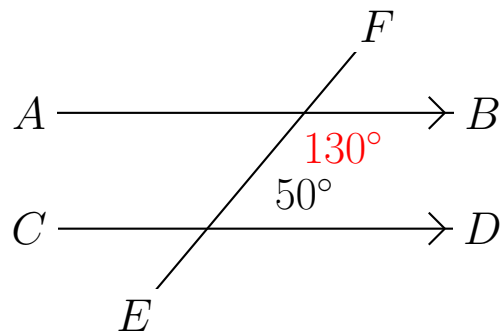
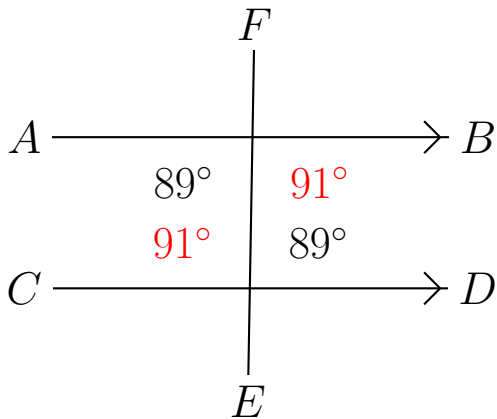
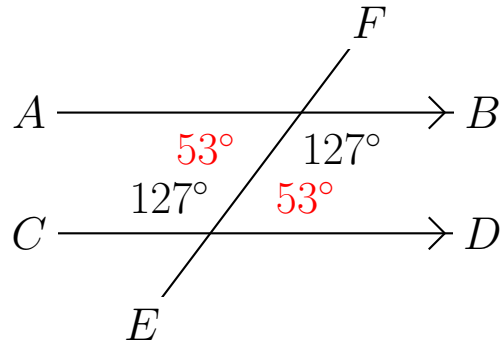
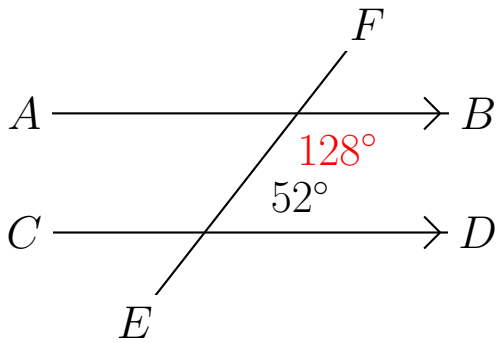
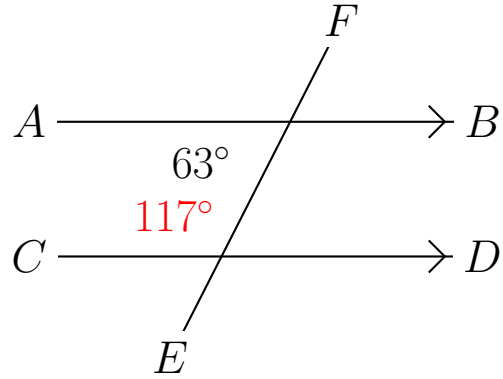
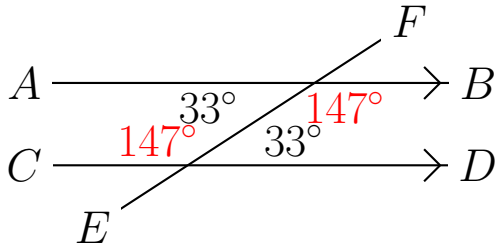

## Co-Interior Angles (C)

Find the co-interior angle measurements for the measured angles.

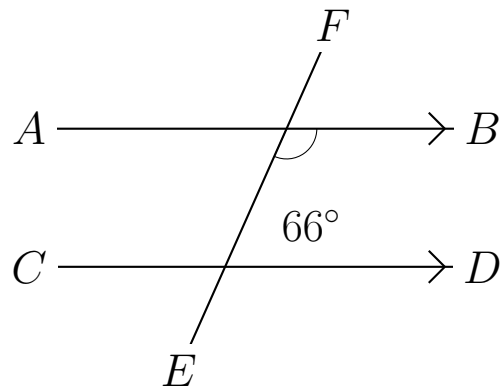
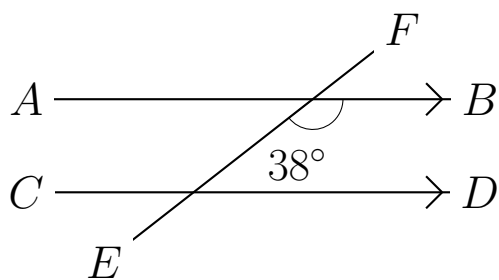
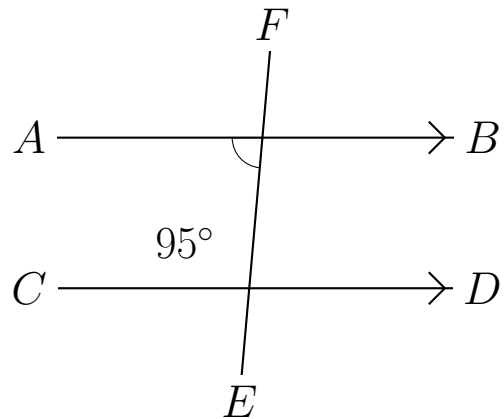
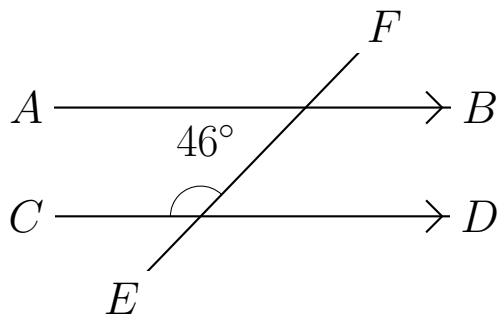
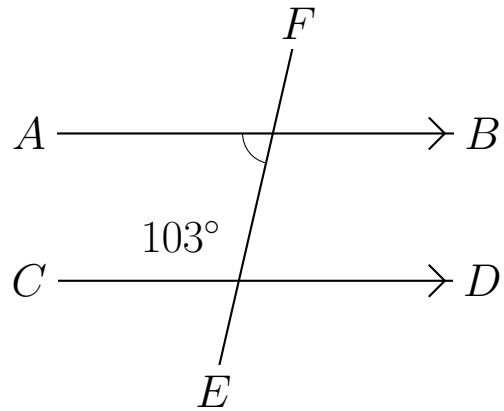
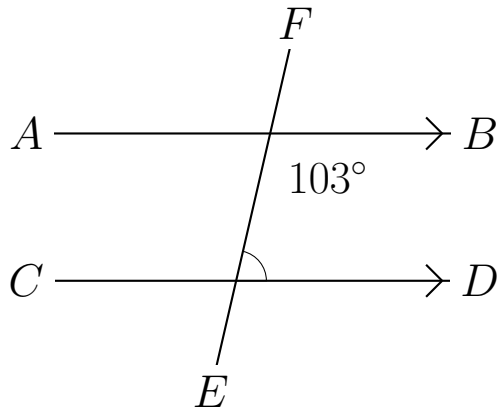

## Co-Interior Angles (C) Answers

Find the co-interior angle measurements for the measured angles.

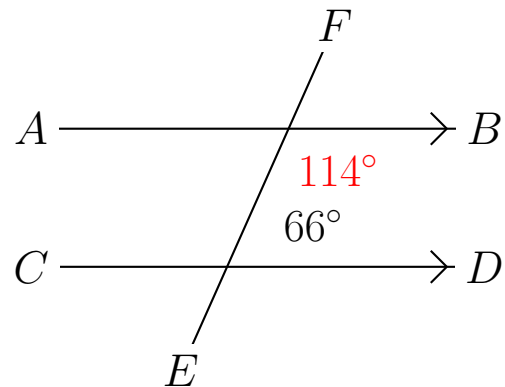
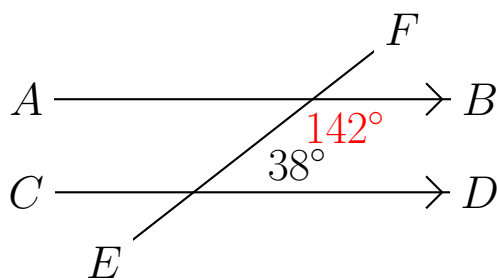
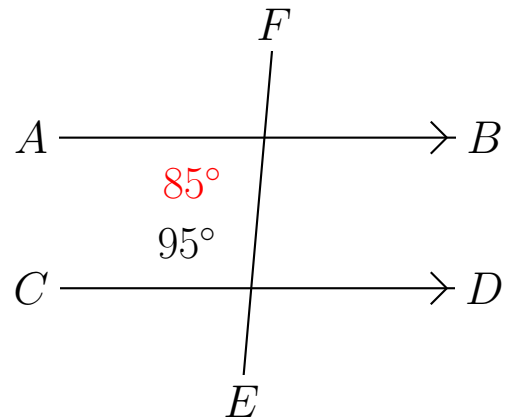
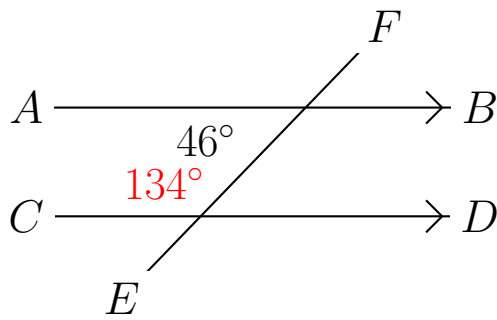
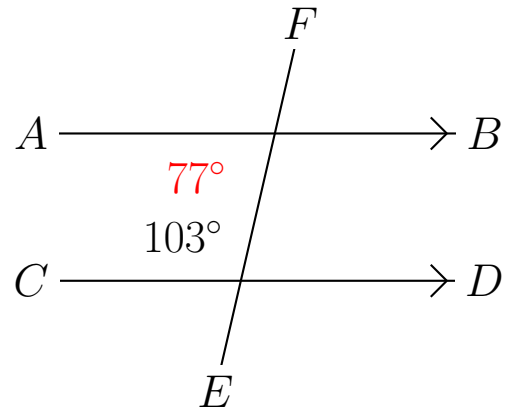
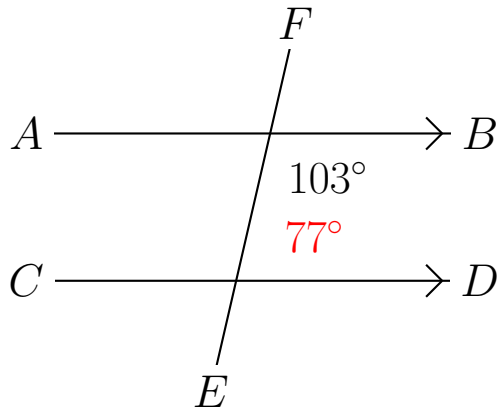

## Co-Interior Angles (D)

Find the co-interior angle measurements for the measured angles.

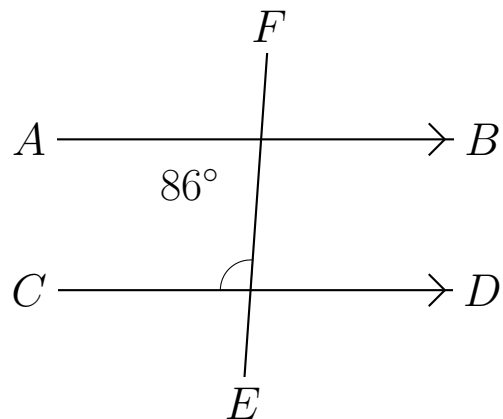
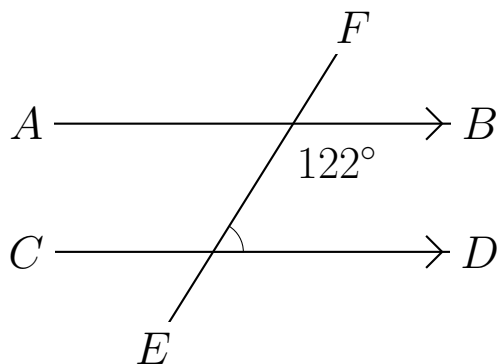
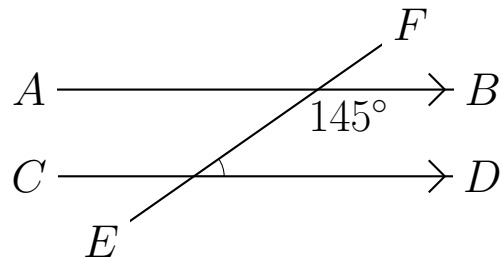
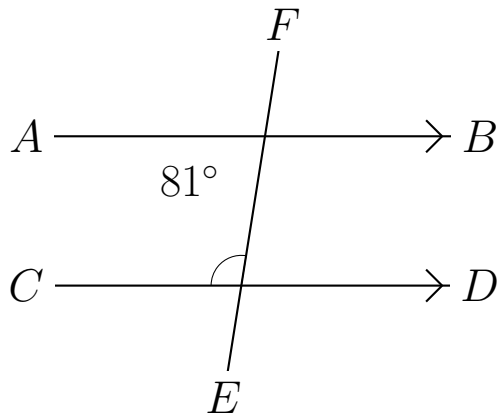
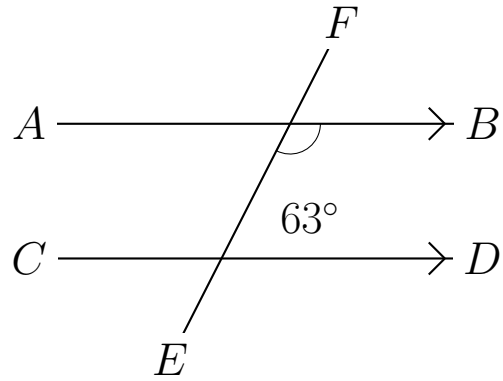
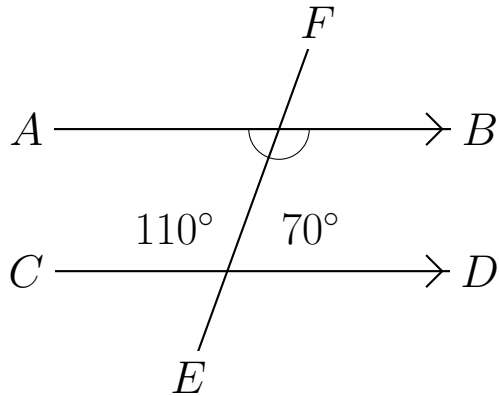

## Co-Interior Angles (D) Answers

Find the co-interior angle measurements for the measured angles.

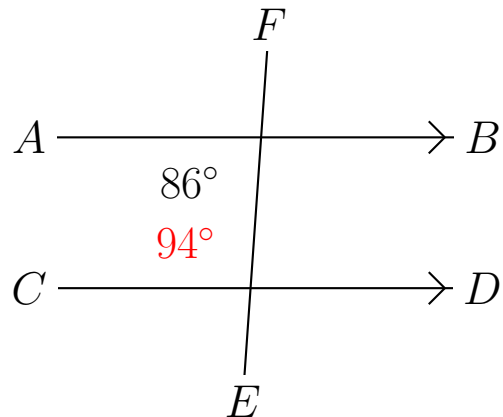
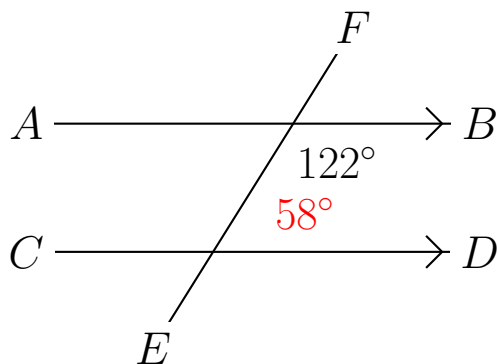
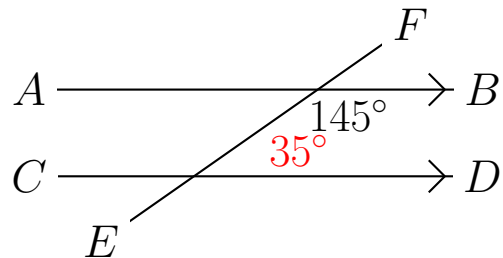
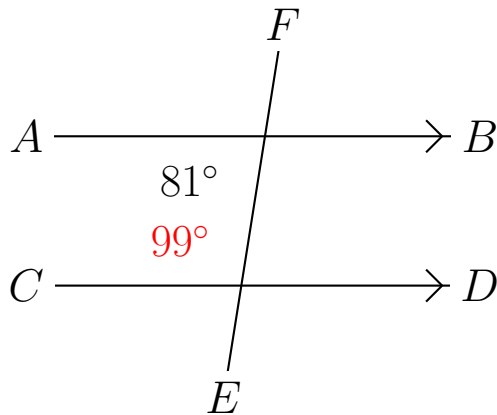
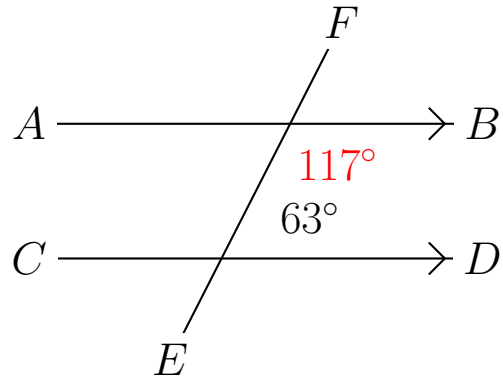
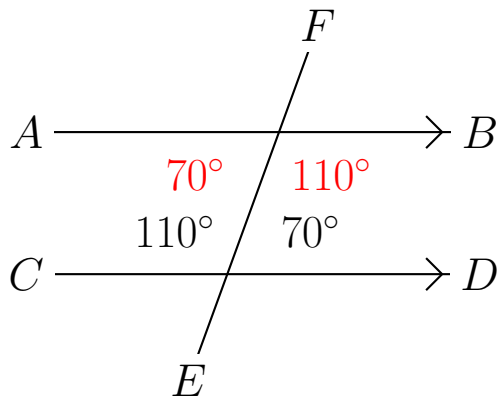



## Co-Interior Angles (E)

Find the co-interior angle measurements for the measured angles.

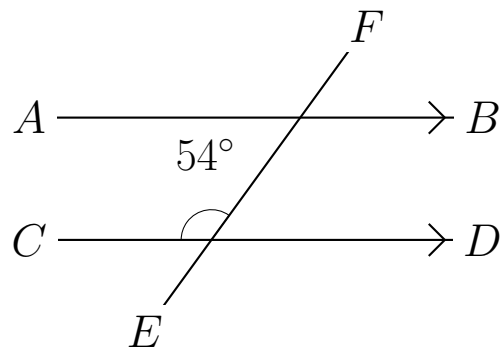
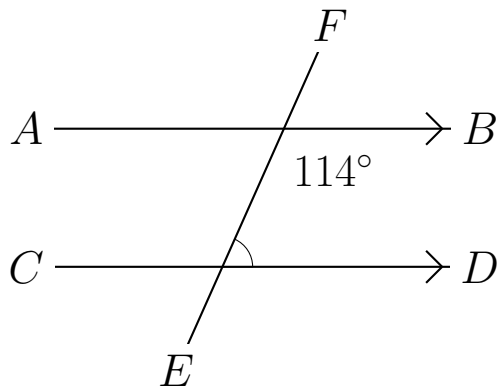
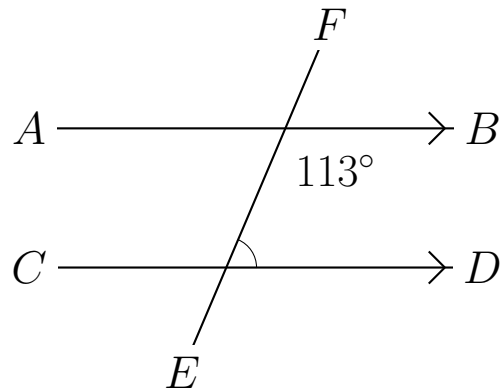
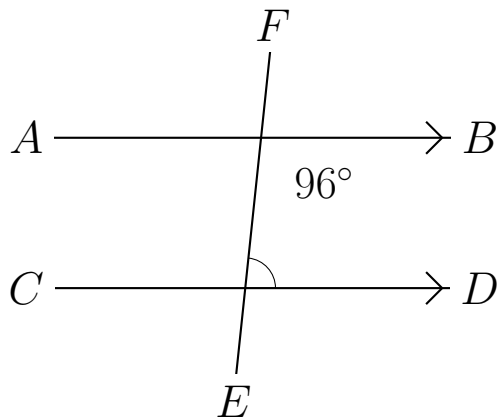
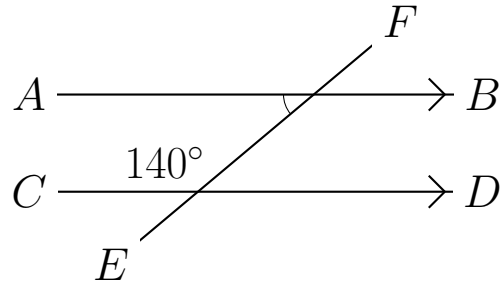
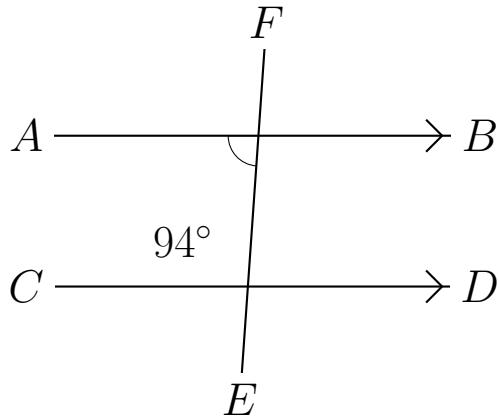

## Co-Interior Angles (E) Answers

Find the co-interior angle measurements for the measured angles.

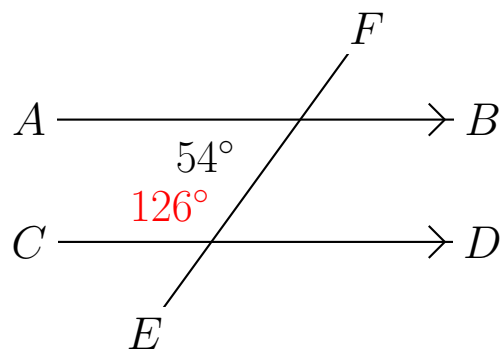
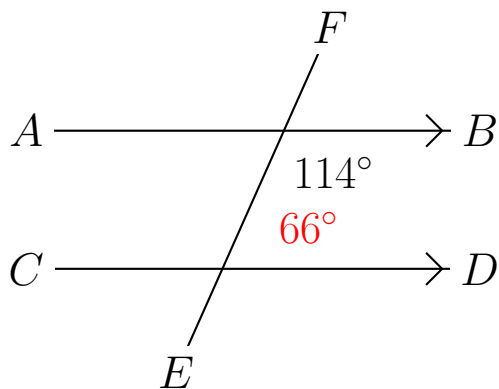
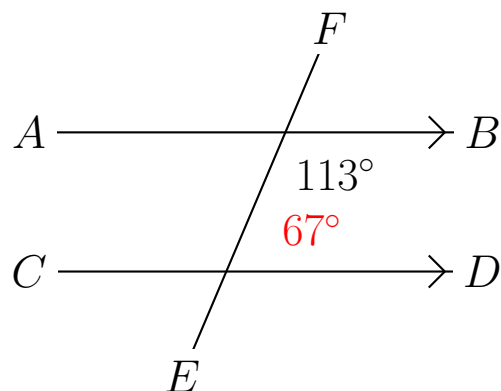
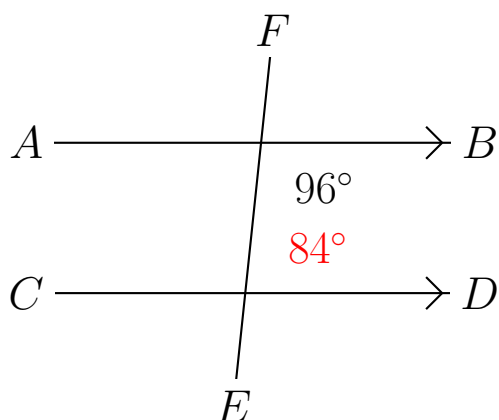
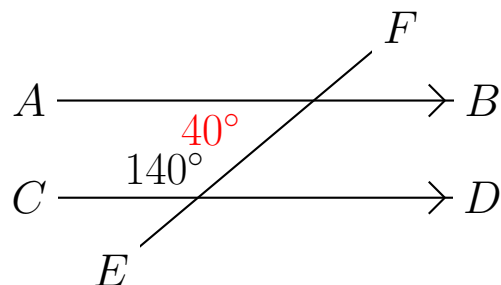
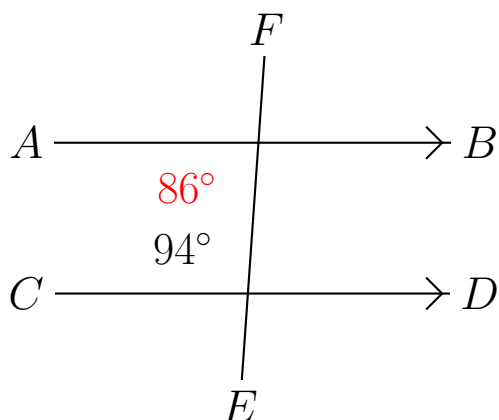

## Co-Interior Angles (F)

Find the co-interior angle measurements for the measured angles.

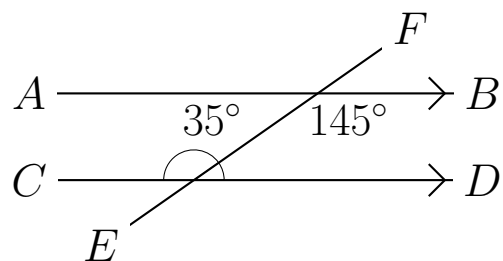
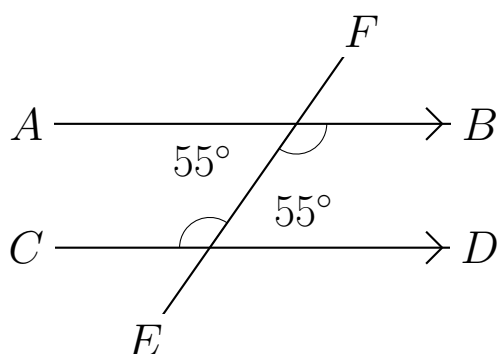
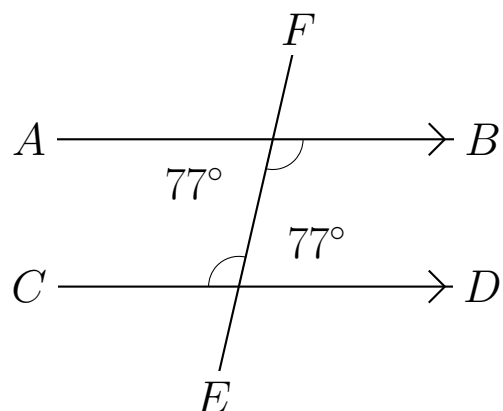
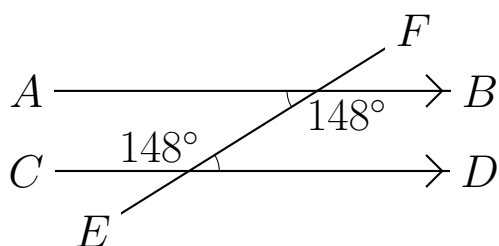
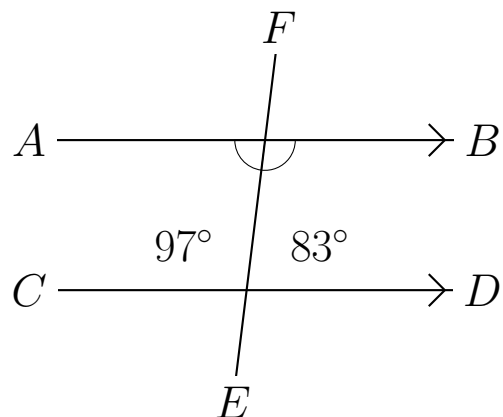
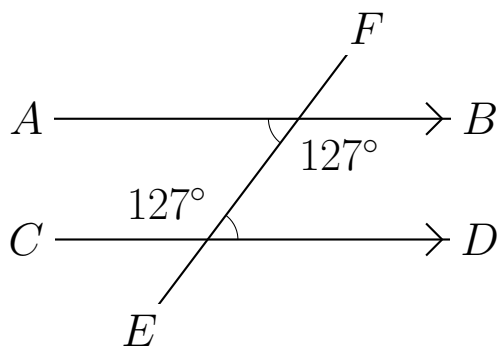

## Co-Interior Angles (F) Answers

Find the co-interior angle measurements for the measured angles.

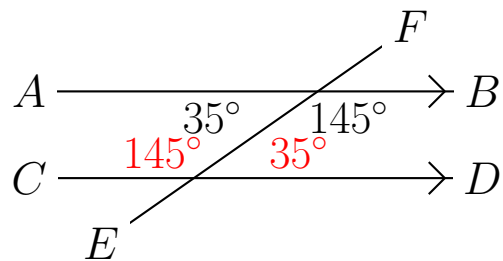
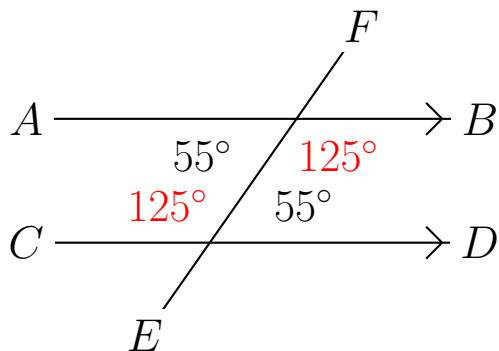
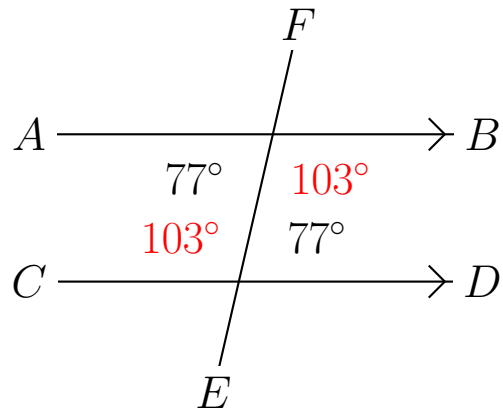
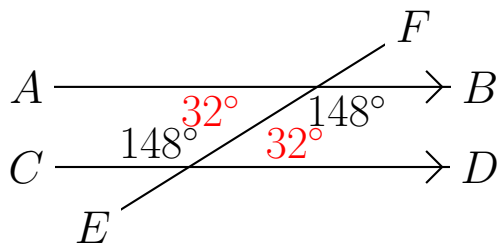
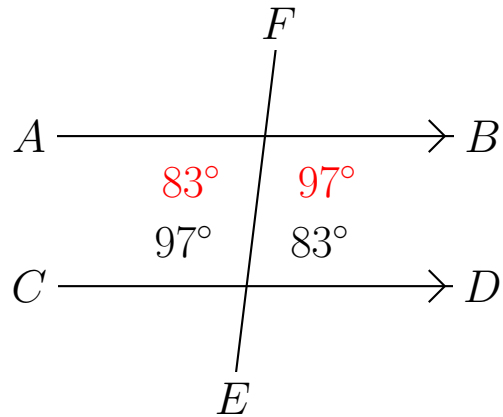
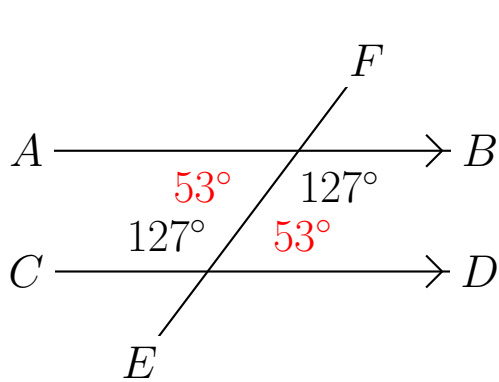

## Co-Interior Angles (G)

Find the co-interior angle measurements for the measured angles.

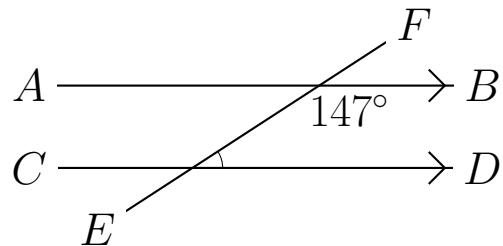
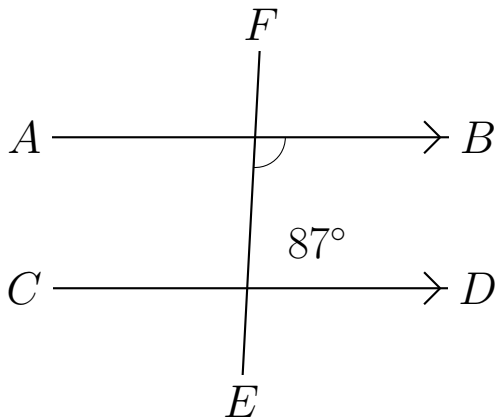
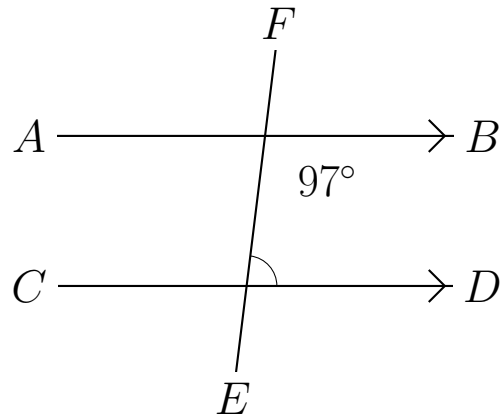
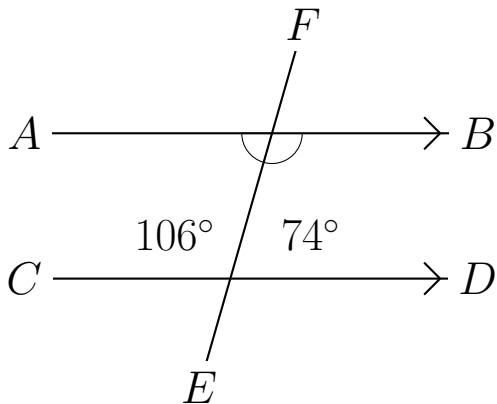
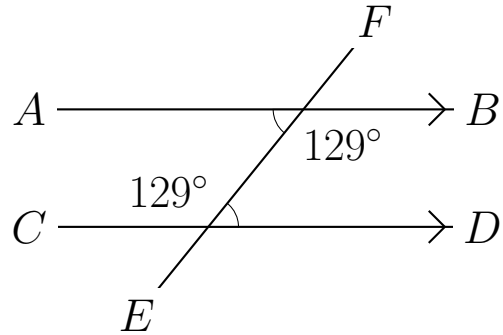
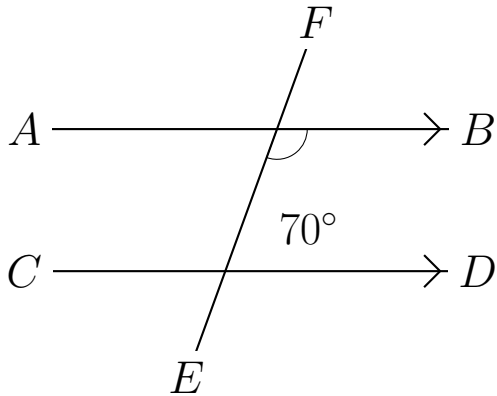

## Co-Interior Angles (G) Answers

Find the co-interior angle measurements for the measured angles.

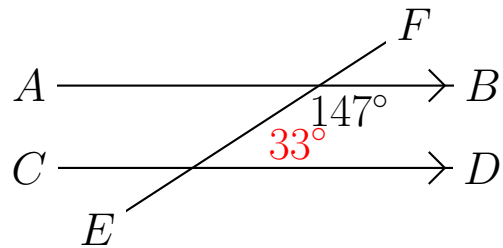
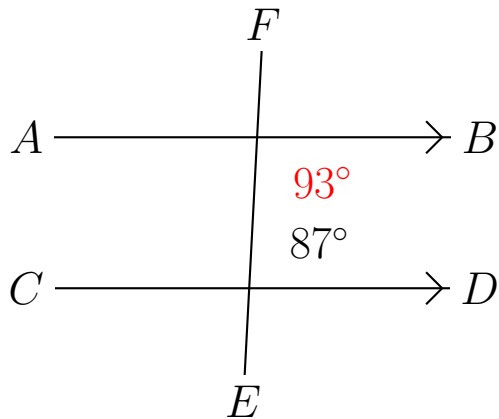
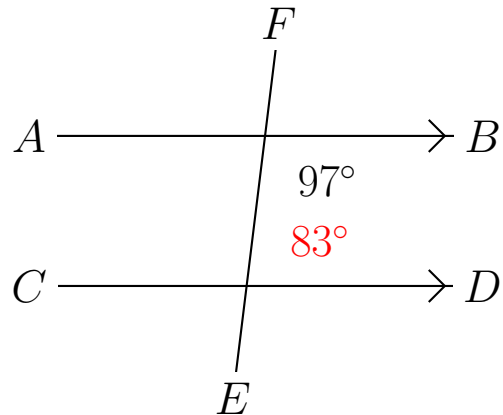
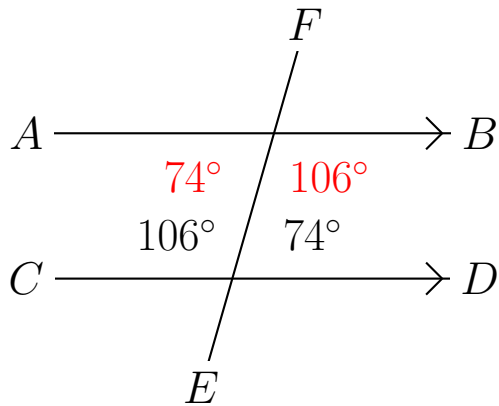
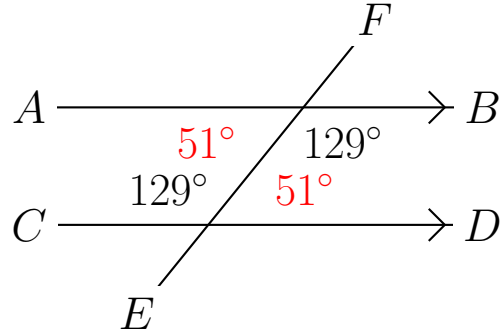
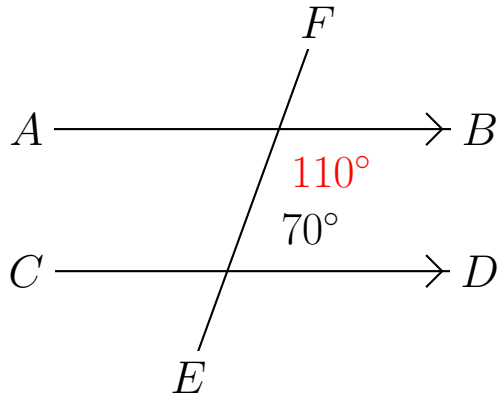

## Co-Interior Angles (H)

Find the co-interior angle measurements for the measured angles.

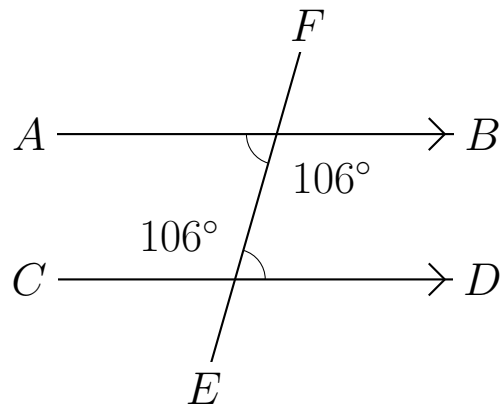
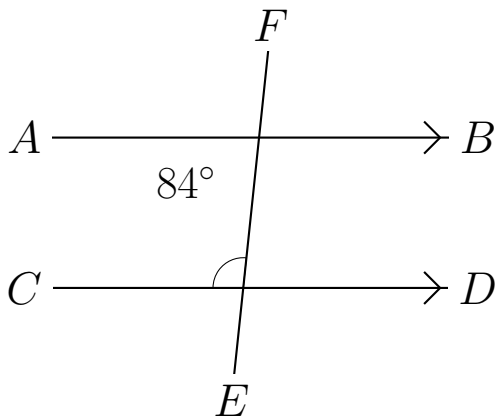
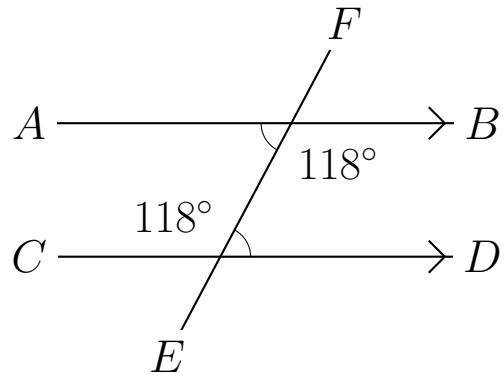
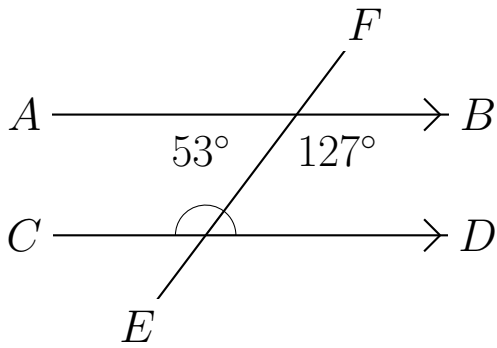
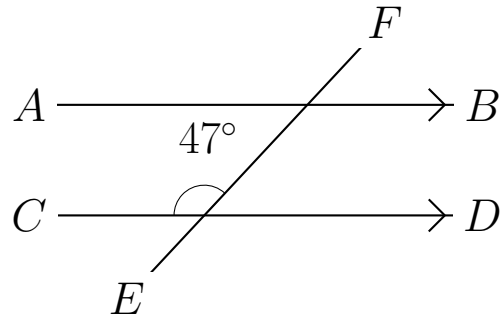
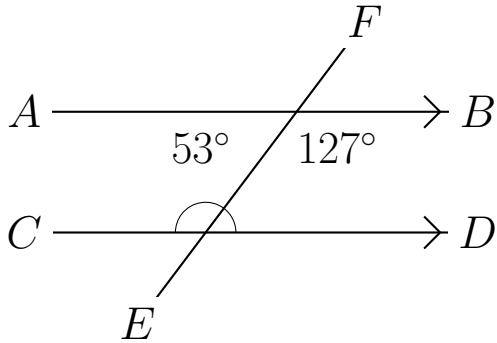

## Co-Interior Angles (H) Answers

Find the co-interior angle measurements for the measured angles.

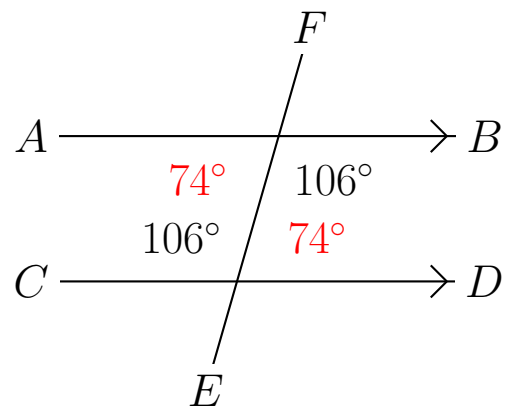
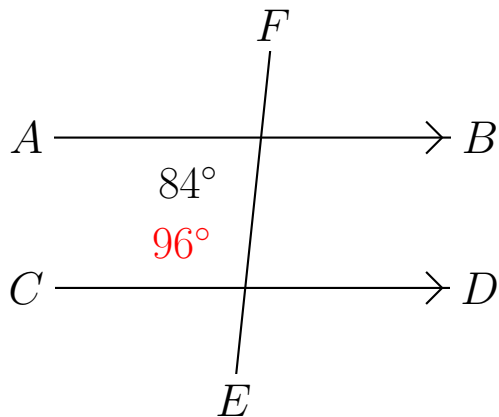
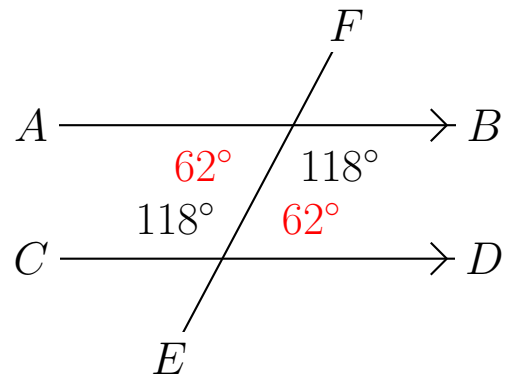
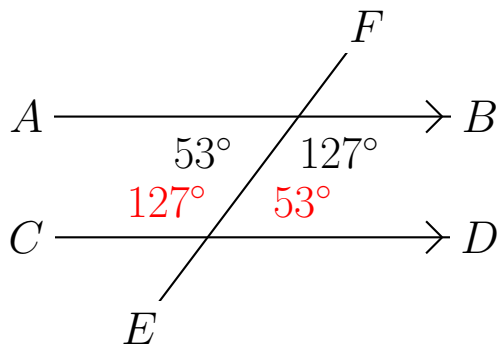
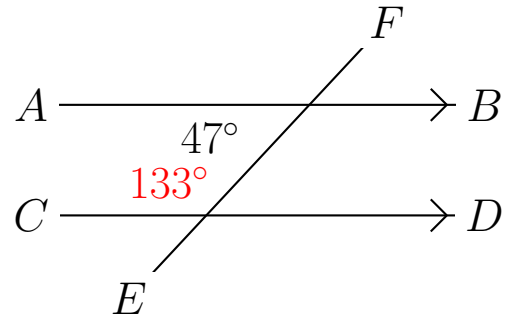
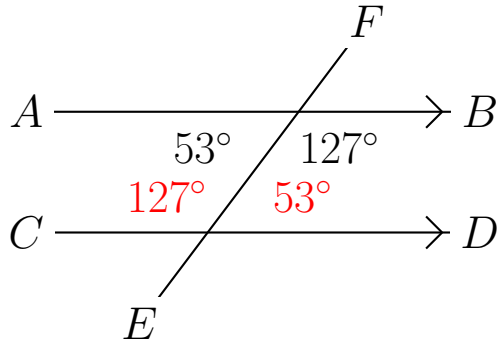



## Co-Interior Angles (I)

Find the co-interior angle measurements for the measured angles.

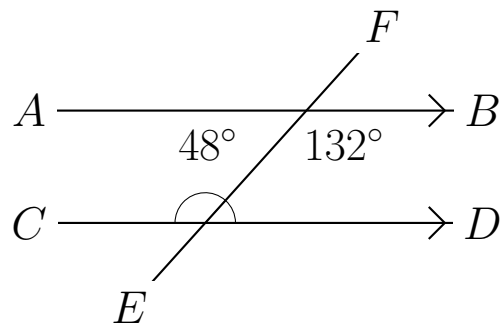
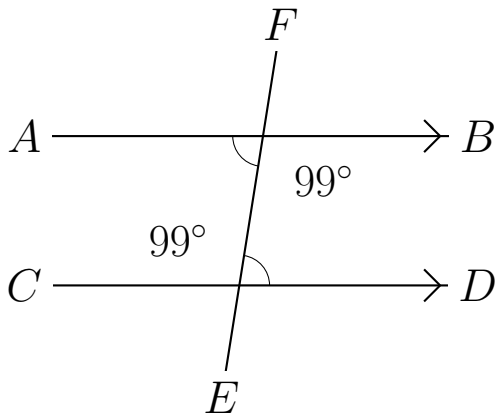
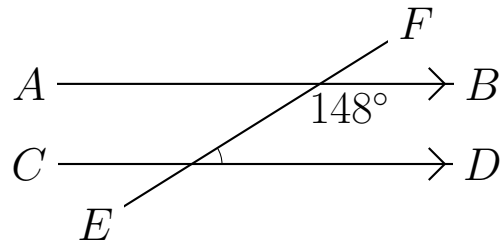
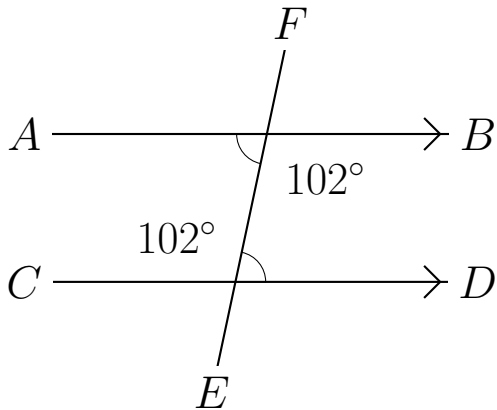
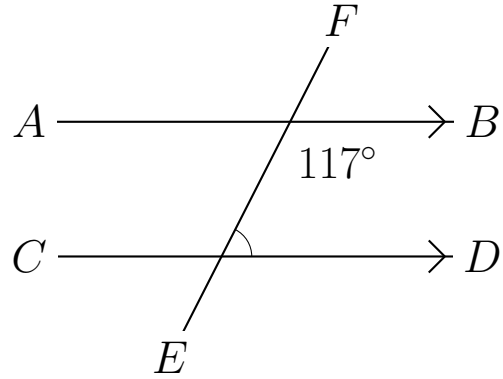
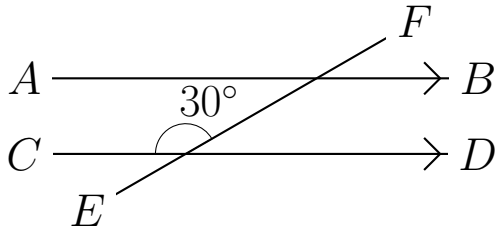

## Co-Interior Angles (I) Answers

Find the co-interior angle measurements for the measured angles.

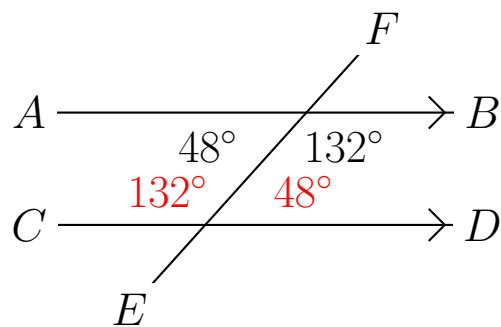
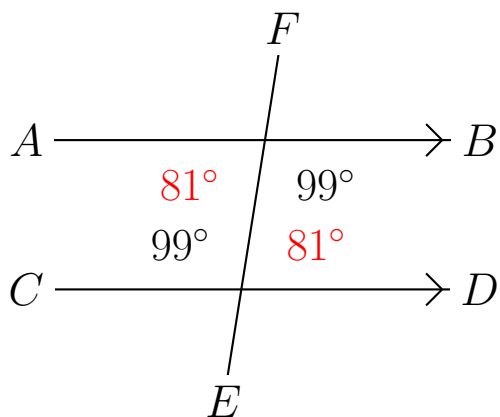
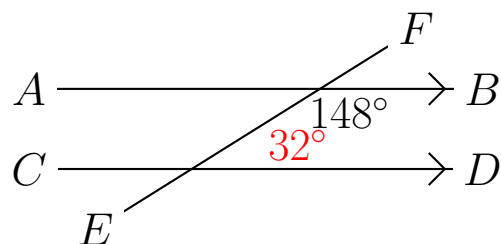
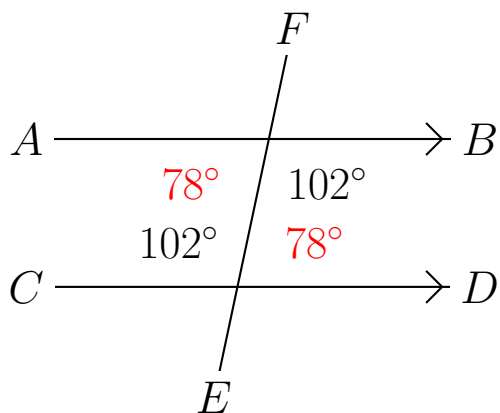
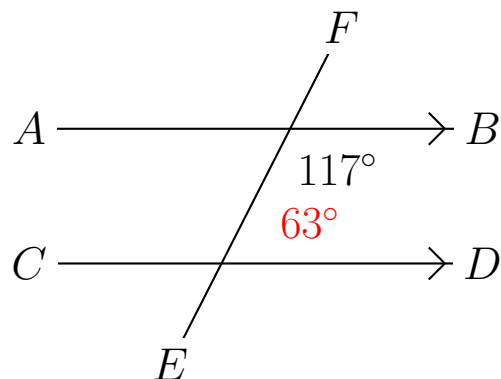
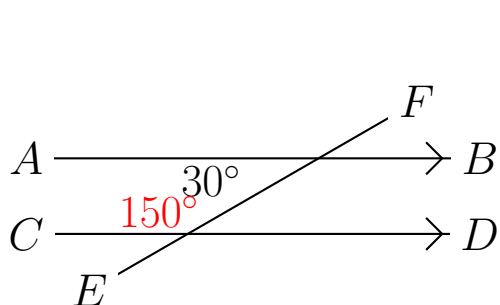

## Co-Interior Angles (J)

Find the co-interior angle measurements for the measured angles.

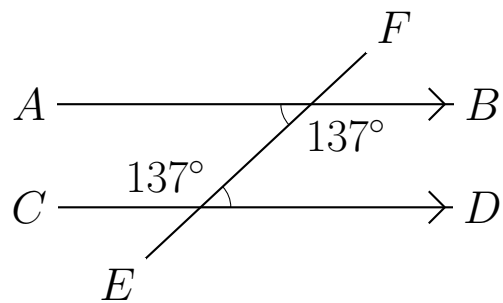
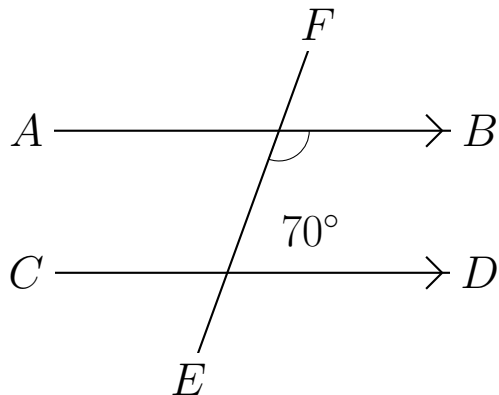
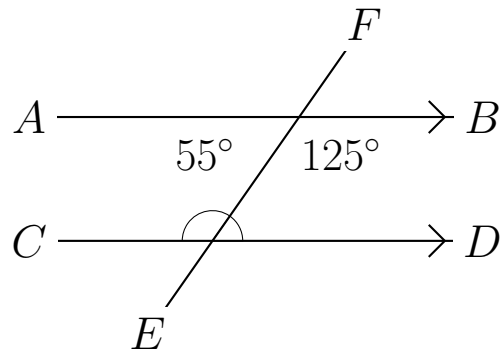
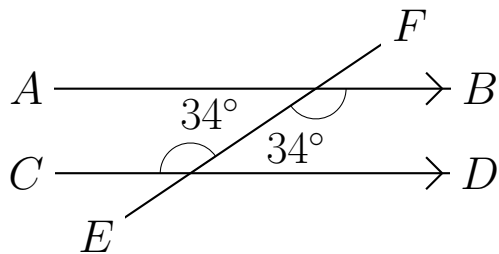
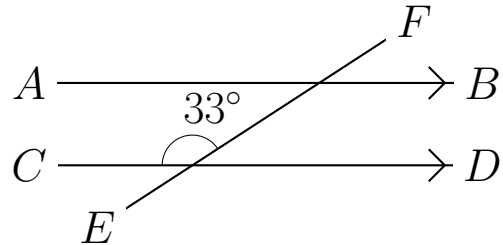
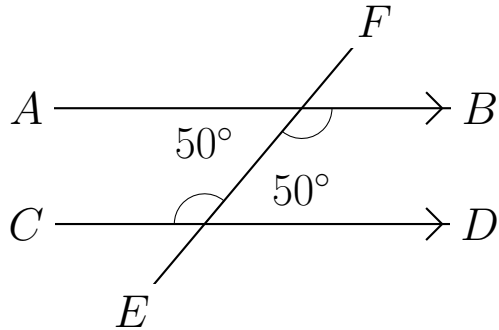

## Co-Interior Angles (J) Answers

Find the co-interior angle measurements for the measured angles.

