

Alternate Angles (A)

Find the alternate angle measurements for the measured angles.

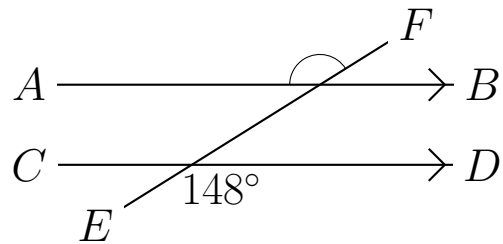
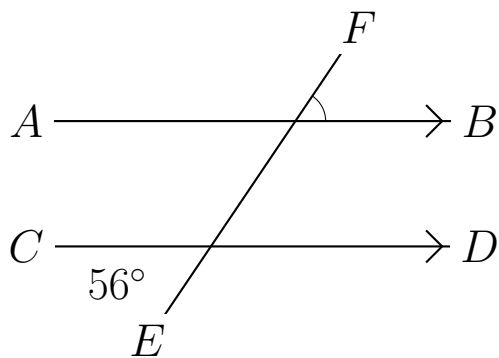
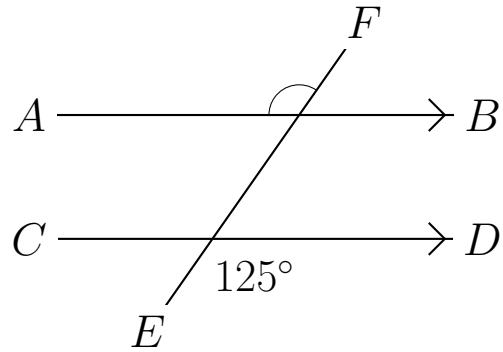
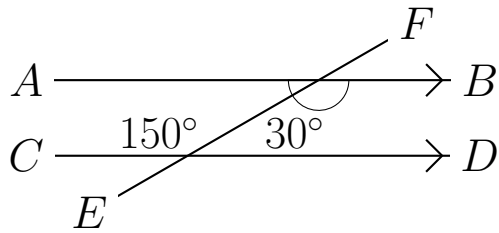
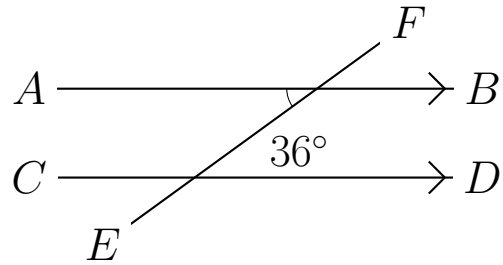
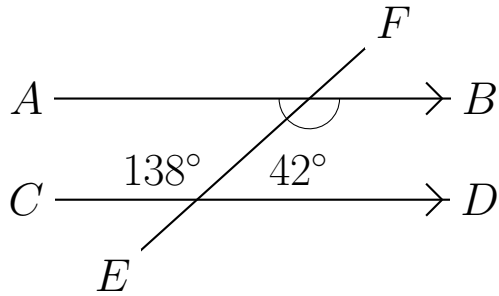

Alternate Angles (A) Answers

Find the alternate angle measurements for the measured angles.

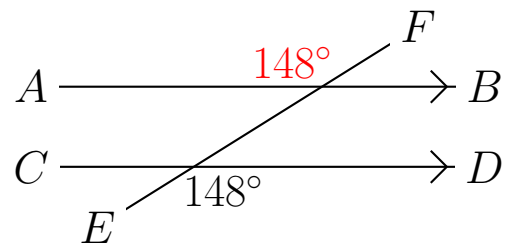
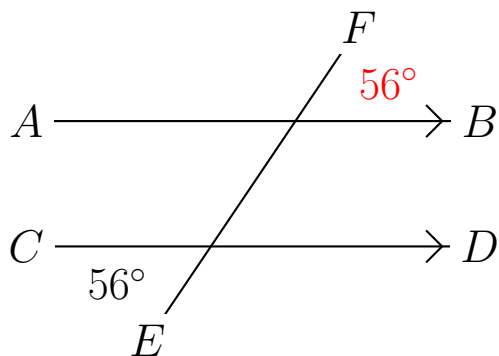
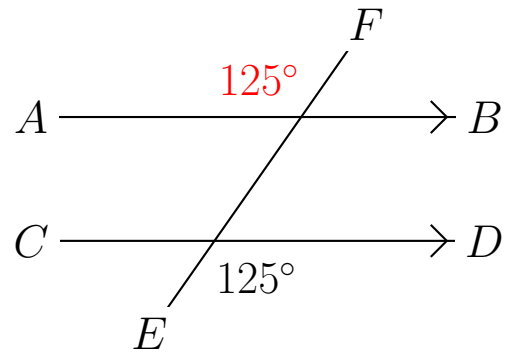
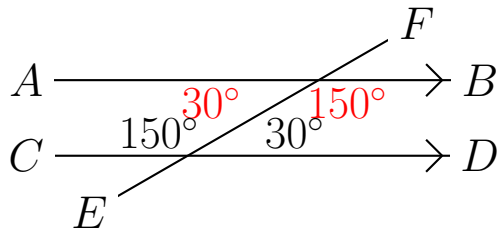
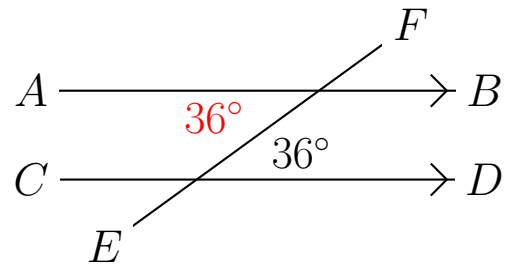
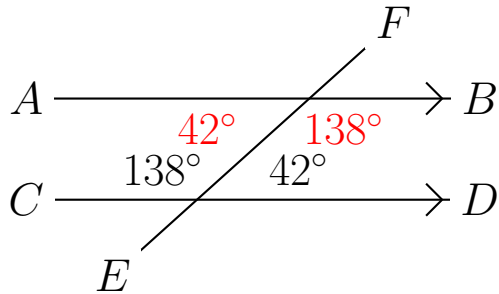

Alternate Angles (B)

Find the alternate angle measurements for the measured angles.

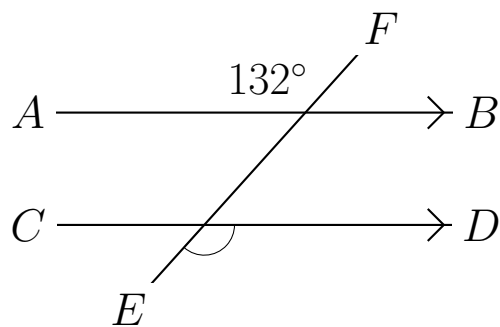
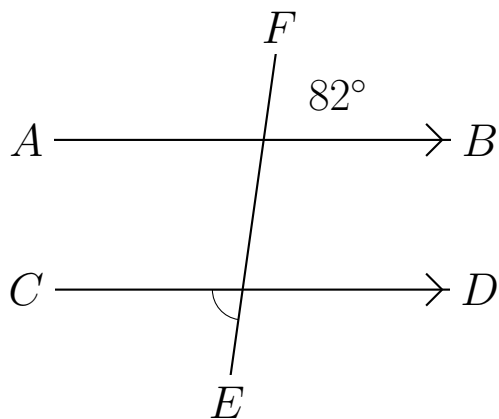
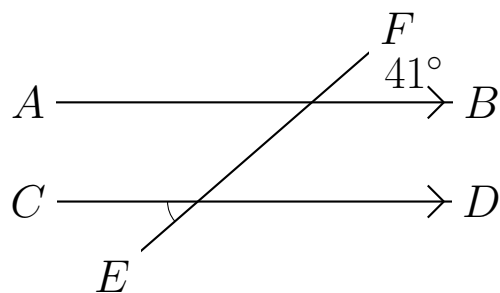
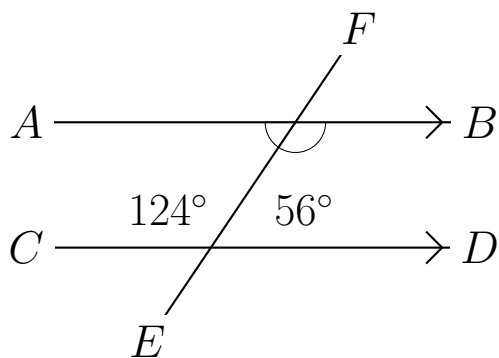
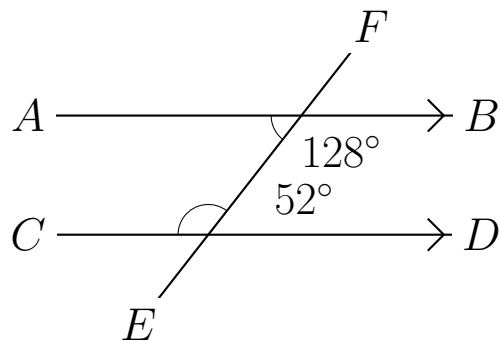
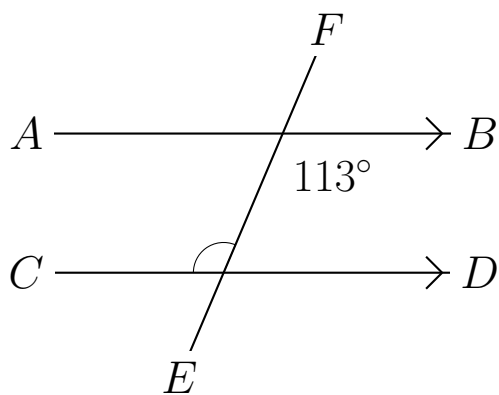

Alternate Angles (B) Answers

Find the alternate angle measurements for the measured angles.

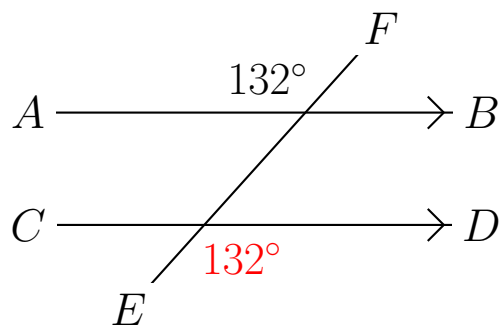
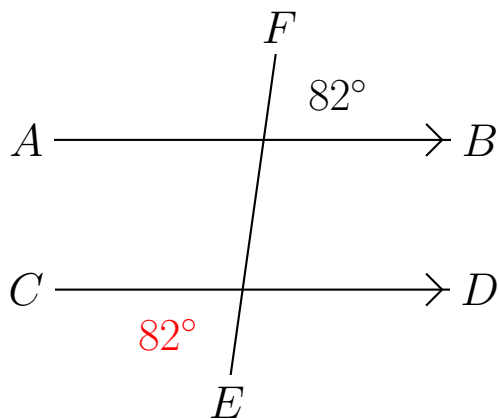
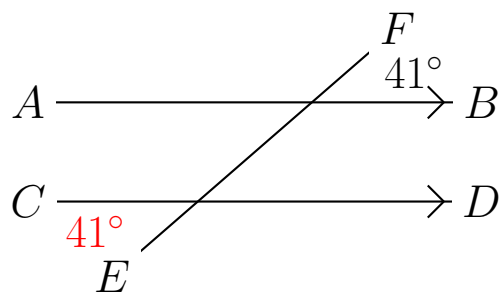
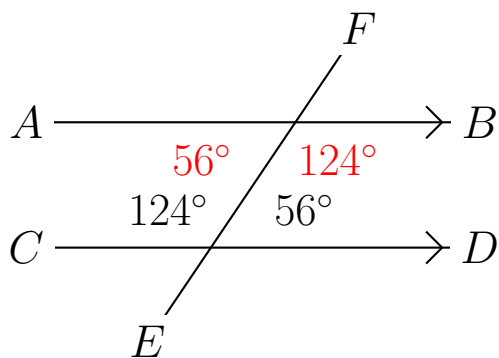
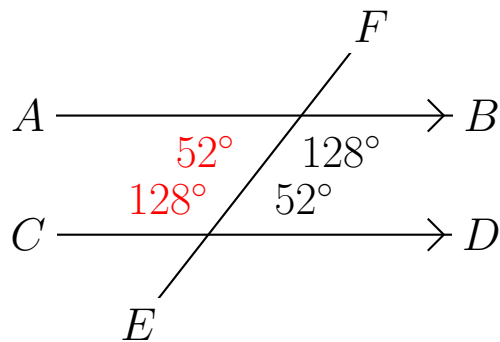
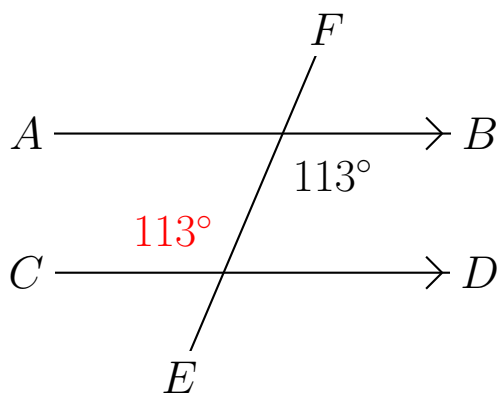

Alternate Angles (C)

Find the alternate angle measurements for the measured angles.

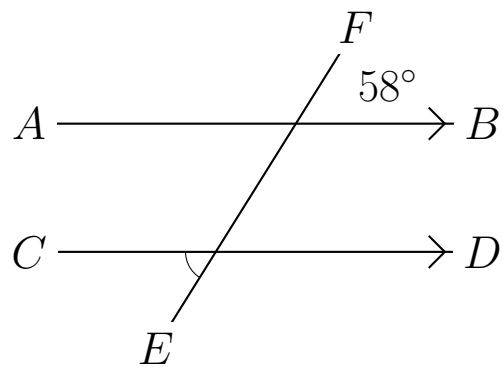
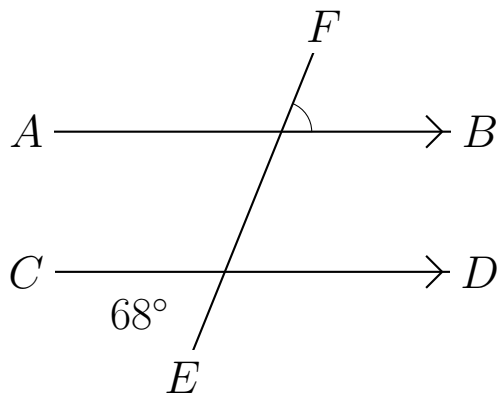
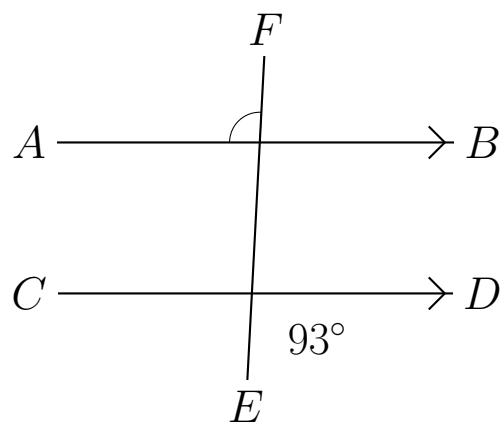
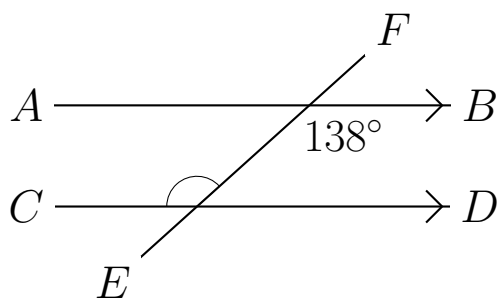
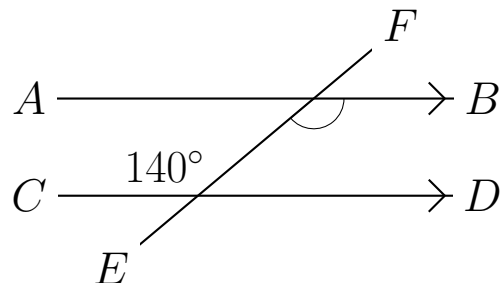
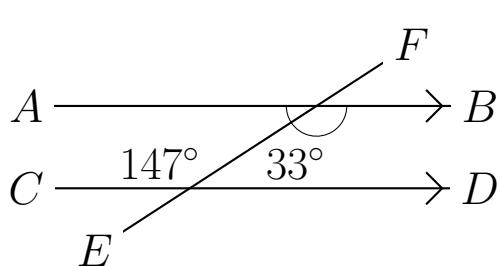

Alternate Angles (C) Answers

Find the alternate angle measurements for the measured angles.

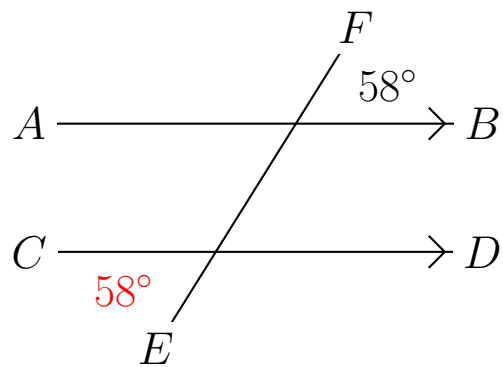
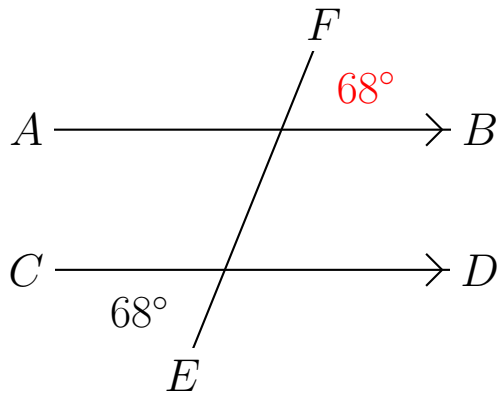
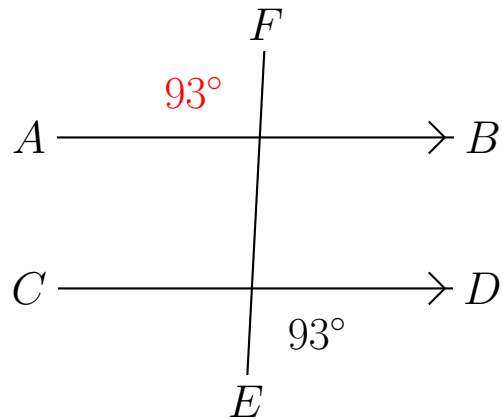
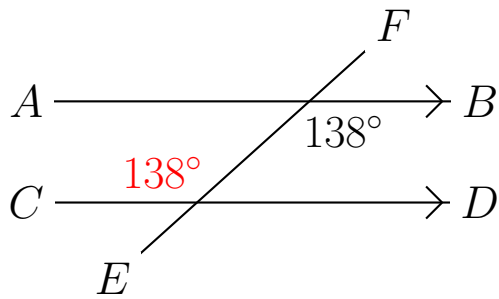
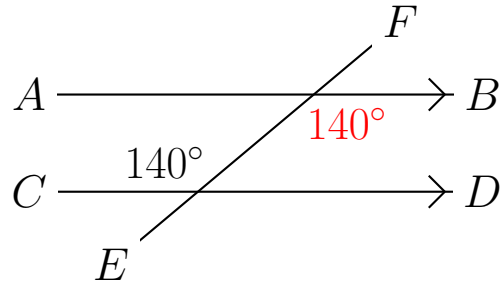
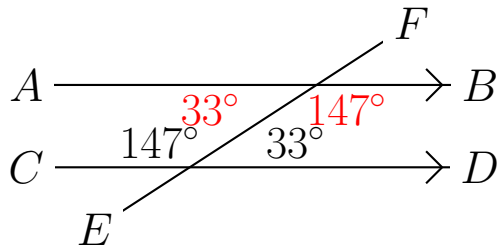

Alternate Angles (D)

Find the alternate angle measurements for the measured angles.

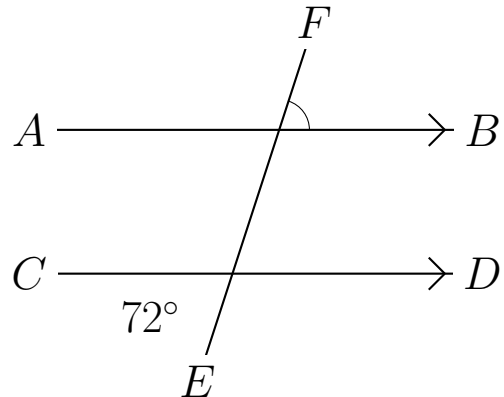
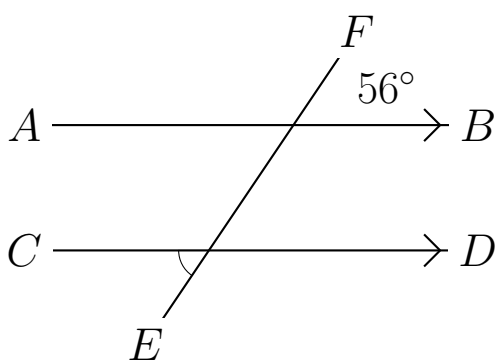
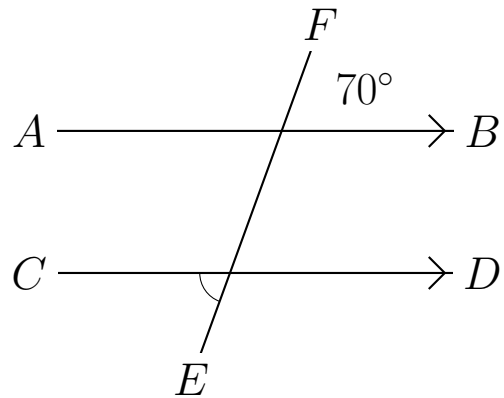
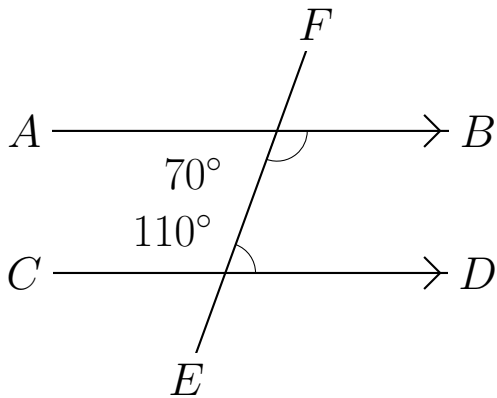
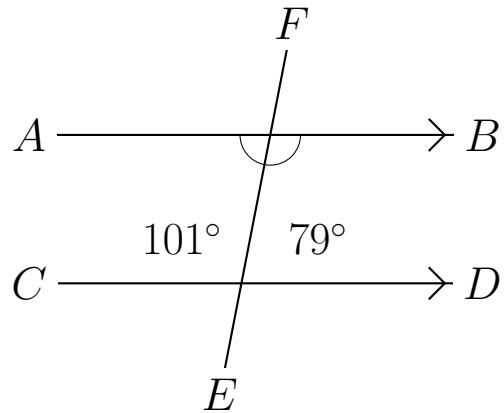
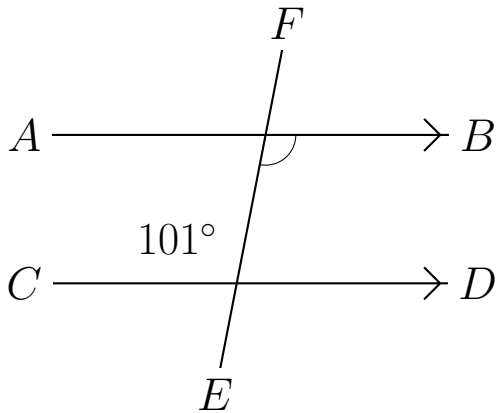

Alternate Angles (D) Answers

Find the alternate angle measurements for the measured angles.

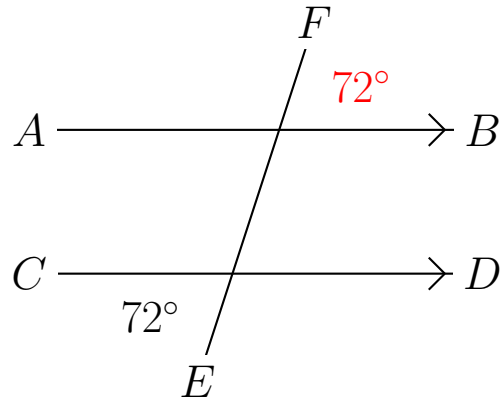
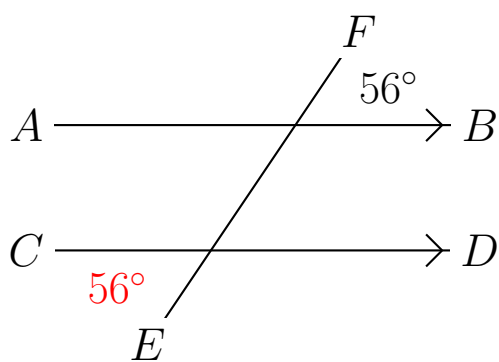
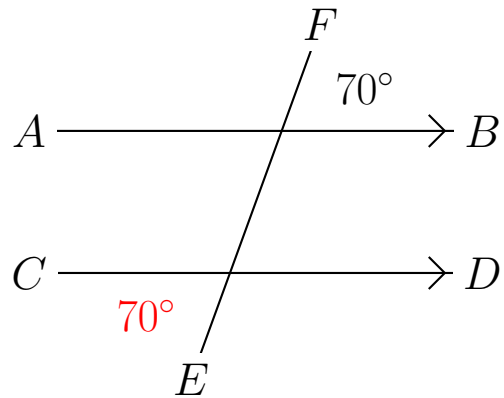
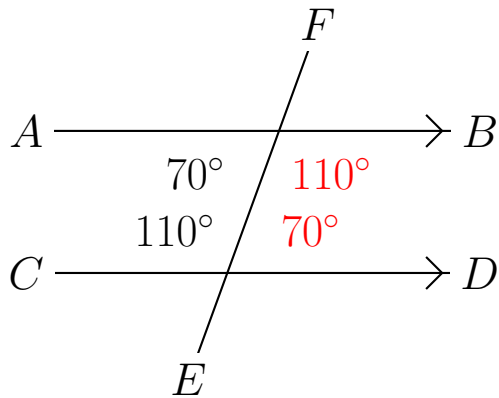
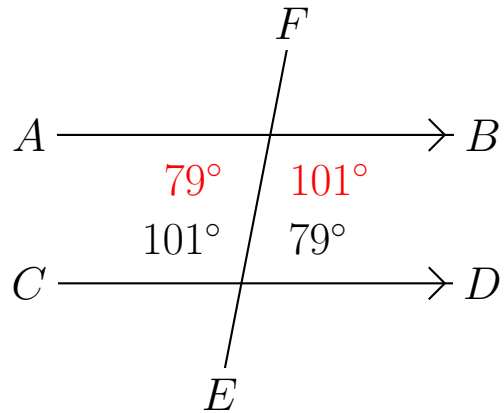
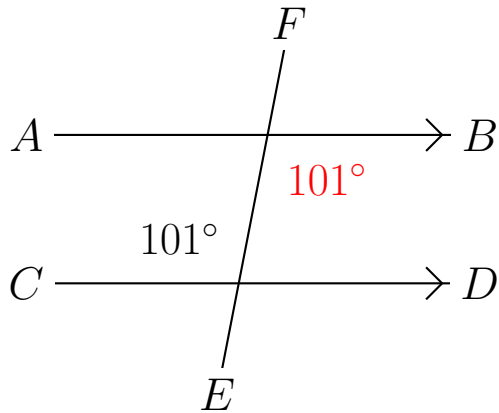

Alternate Angles (E)

Find the alternate angle measurements for the measured angles.

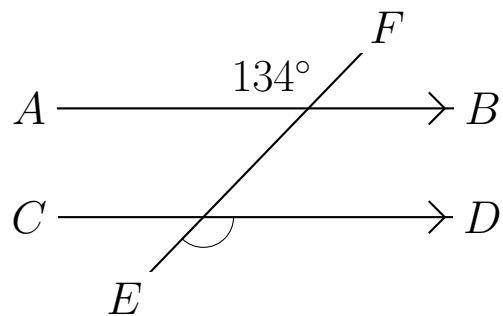
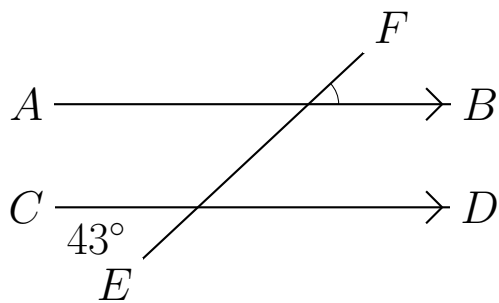
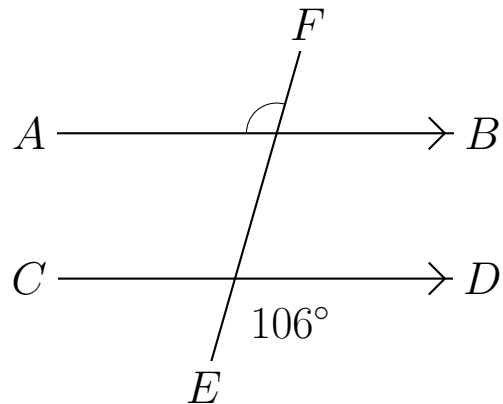
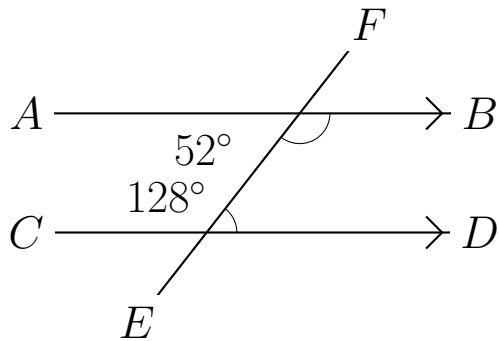
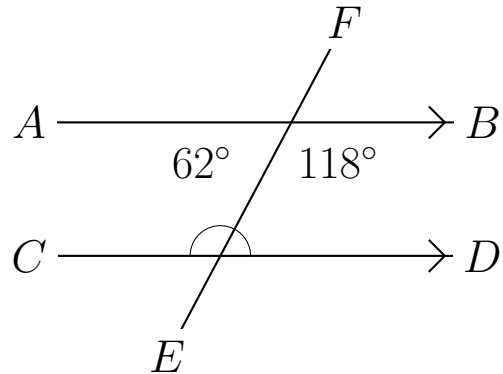
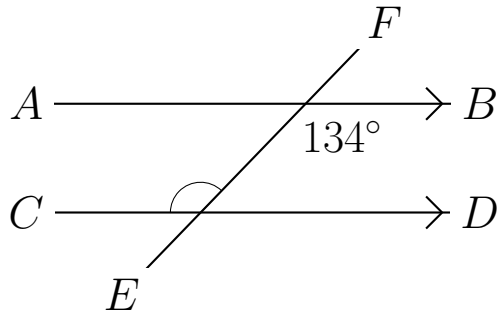

Alternate Angles (E) Answers

Find the alternate angle measurements for the measured angles.

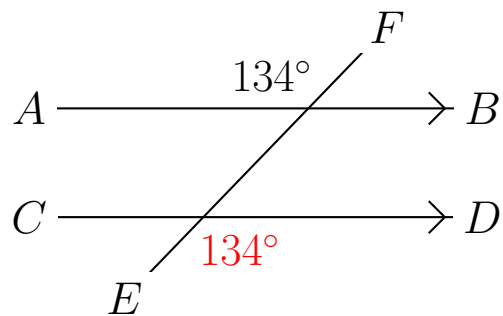
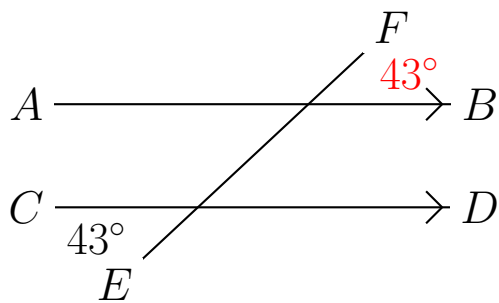
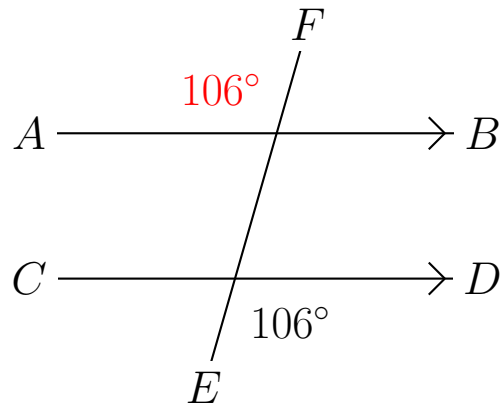
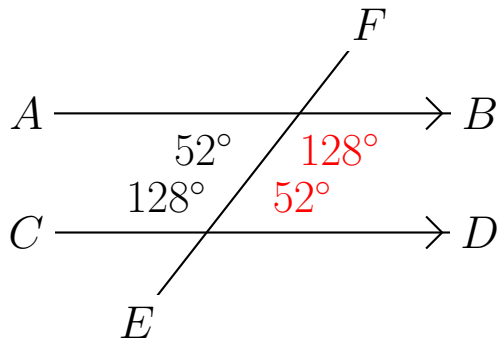
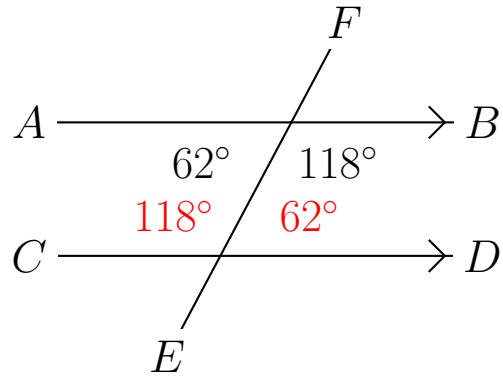
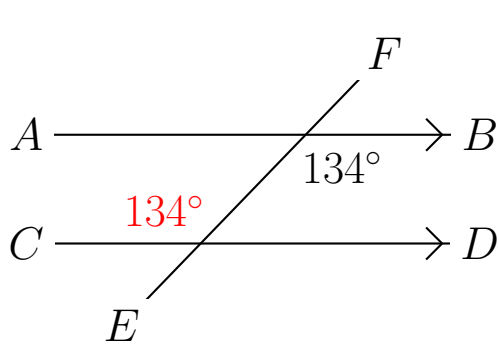

Alternate Angles (F)

Find the alternate angle measurements for the measured angles.

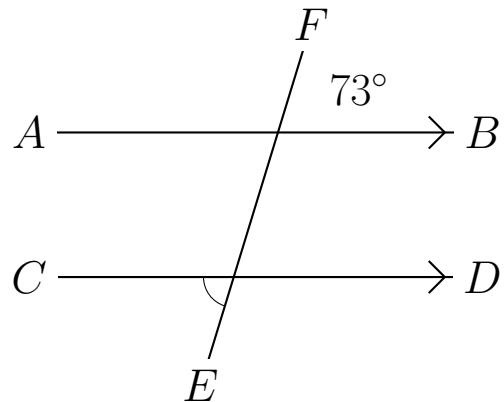
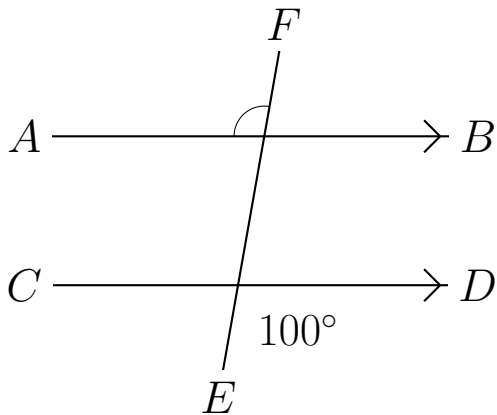
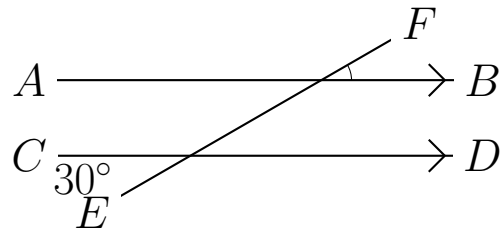
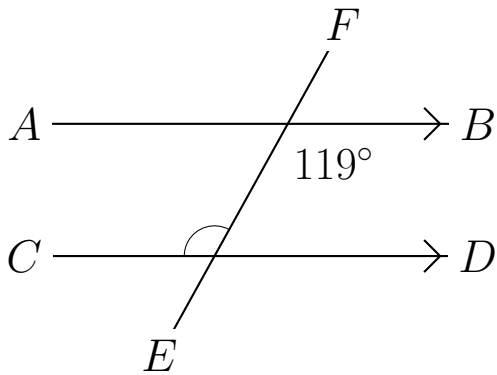
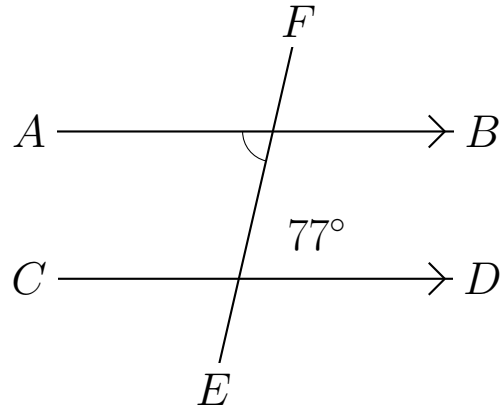
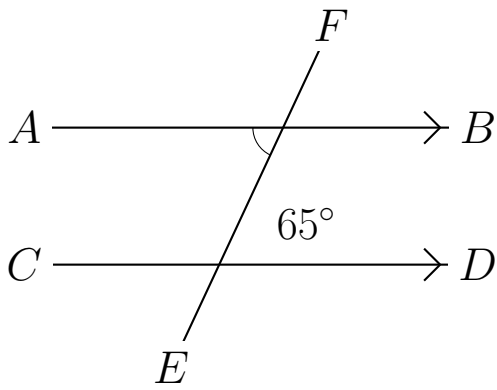

Alternate Angles (F) Answers

Find the alternate angle measurements for the measured angles.

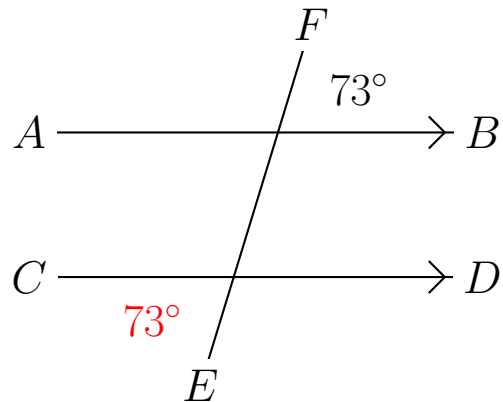
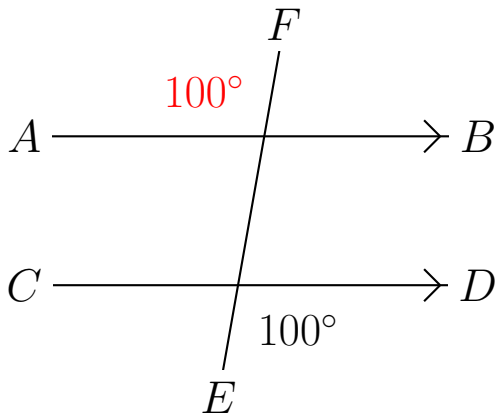
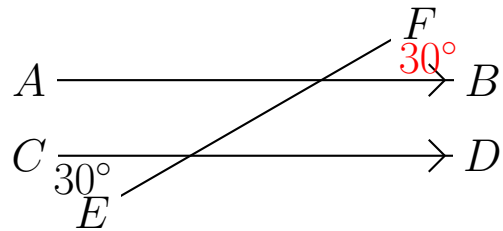
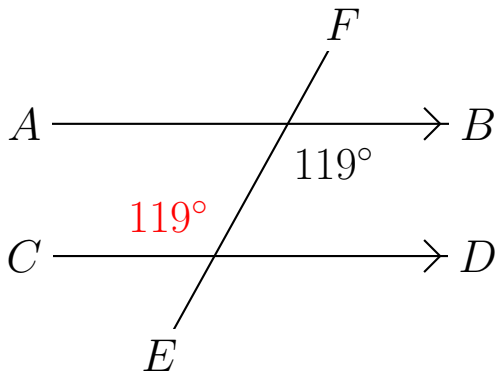
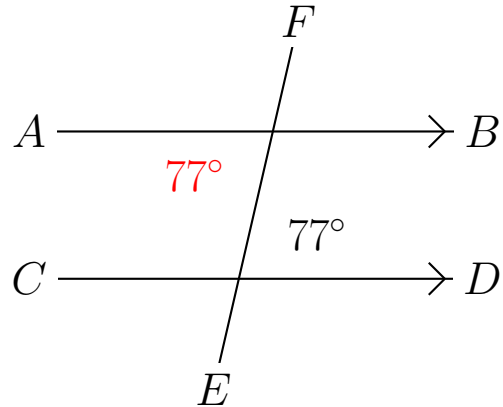
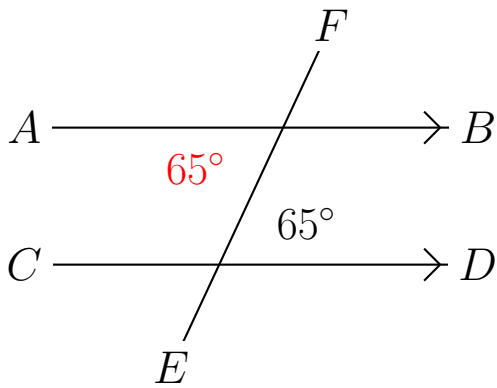

Alternate Angles (G)

Find the alternate angle measurements for the measured angles.

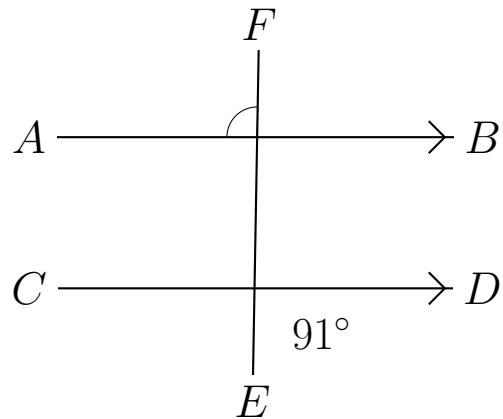
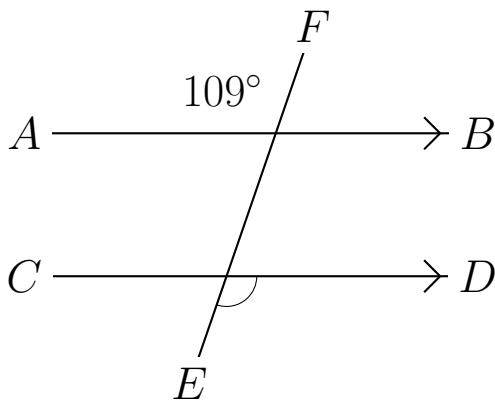
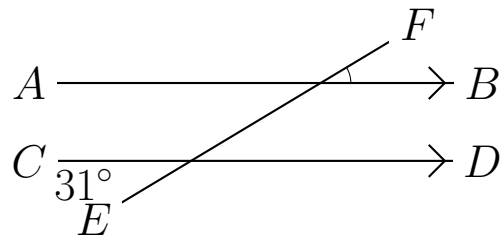
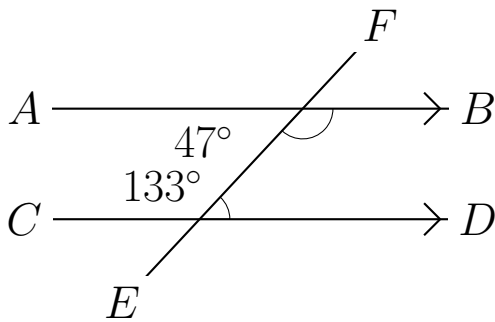
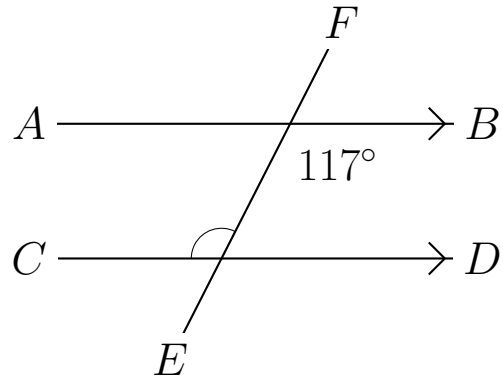
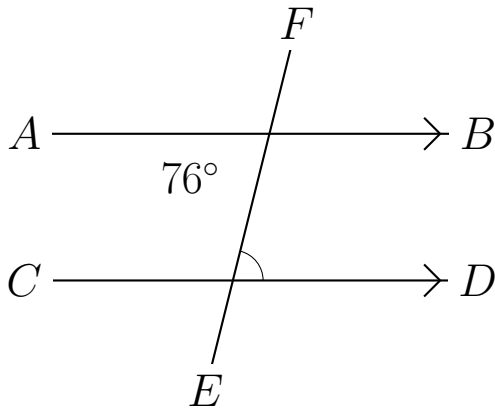

Alternate Angles (G) Answers

Find the alternate angle measurements for the measured angles.

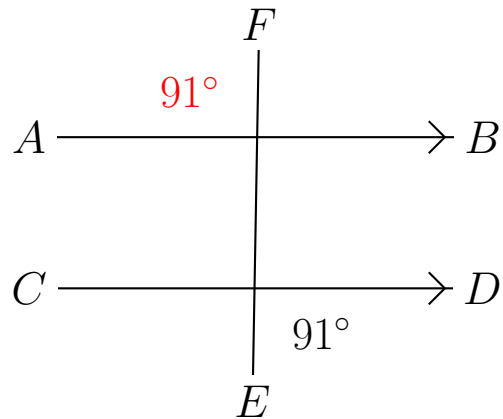
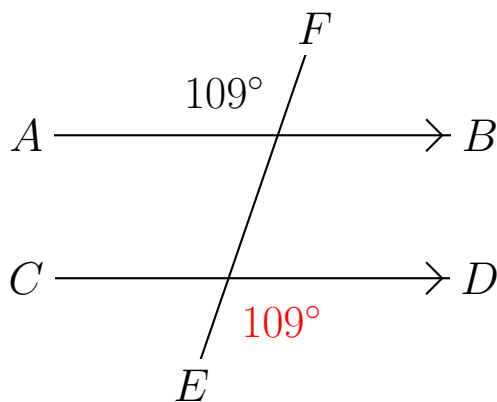
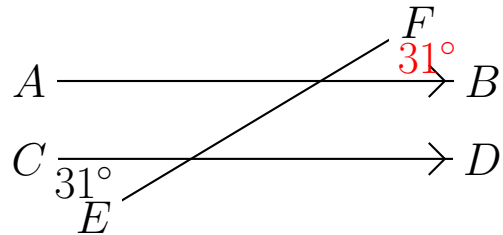
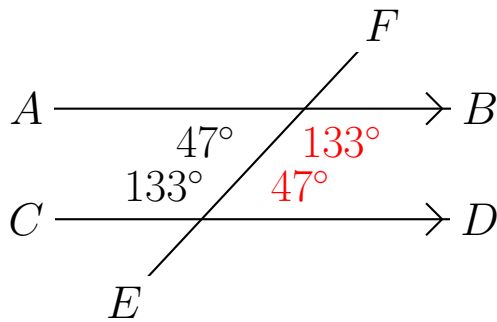
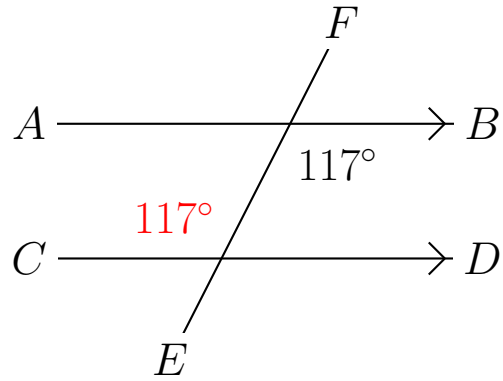
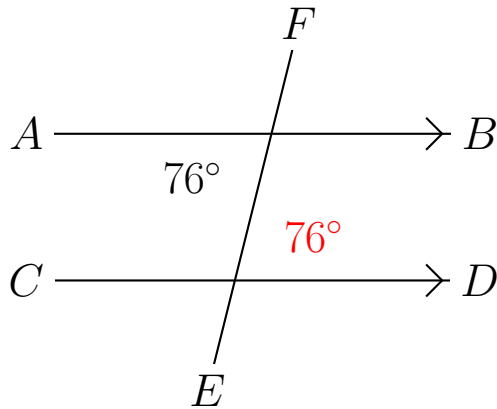

Alternate Angles (H)

Find the alternate angle measurements for the measured angles.

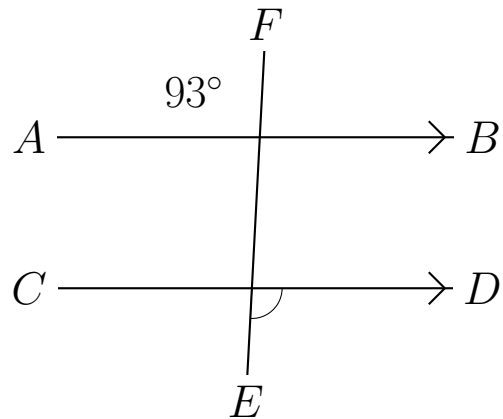
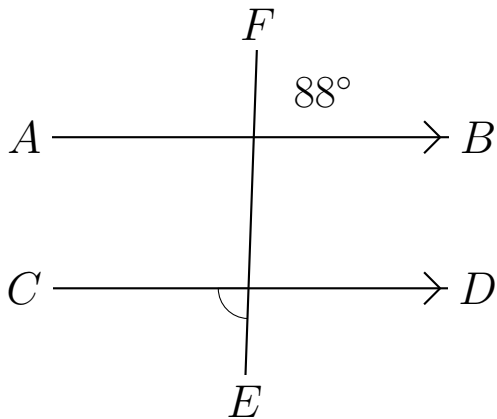
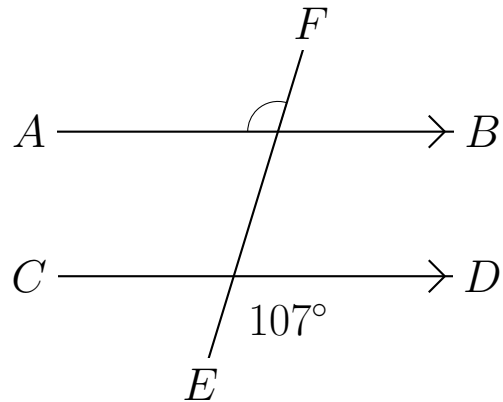
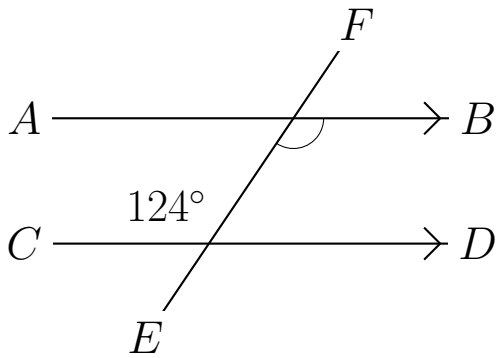
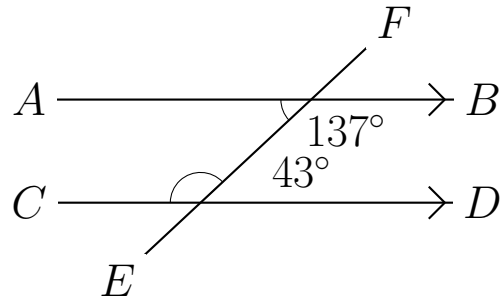
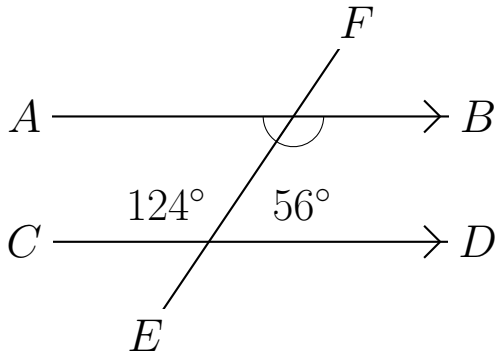

Alternate Angles (H) Answers

Find the alternate angle measurements for the measured angles.

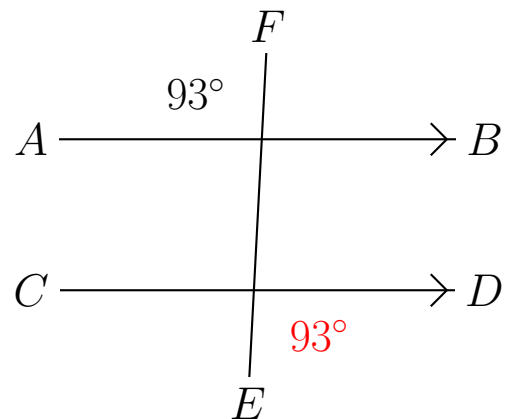
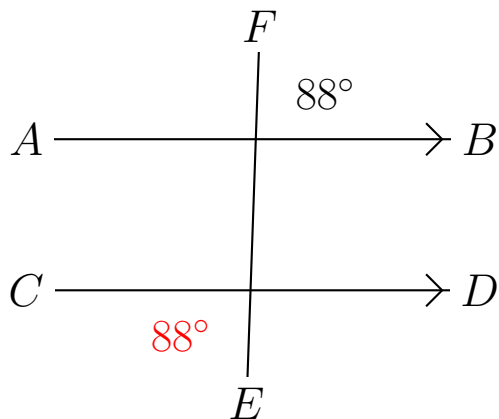
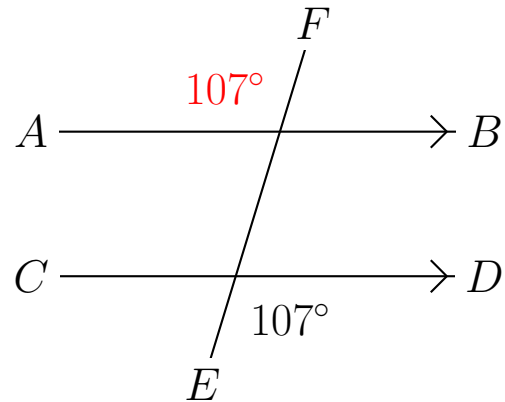
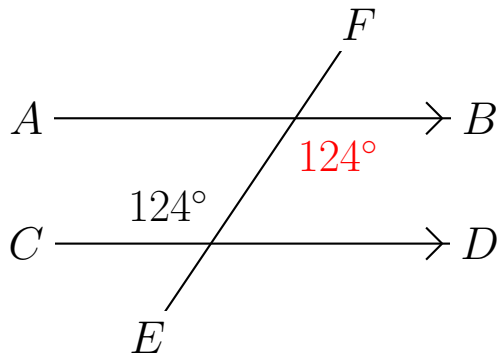
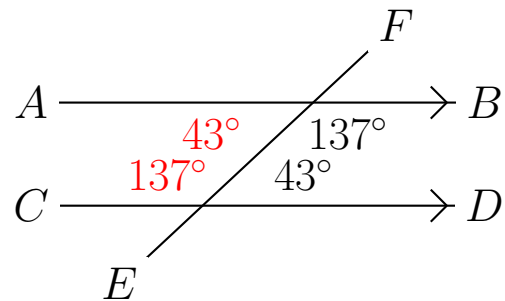
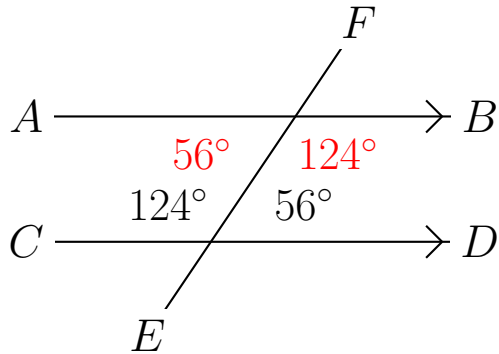

Alternate Angles (I)

Find the alternate angle measurements for the measured angles.

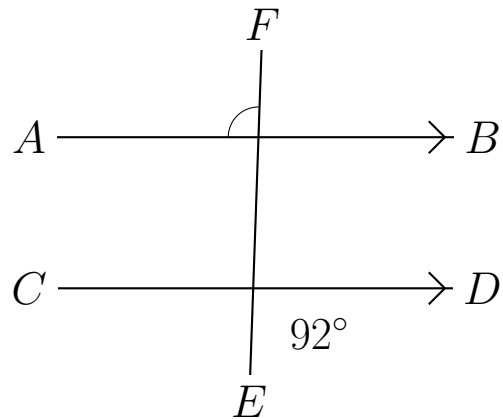
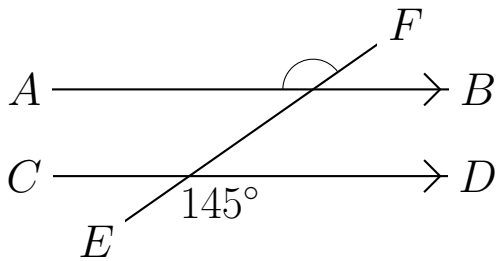
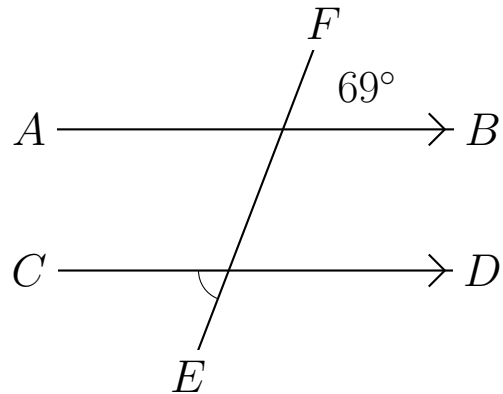
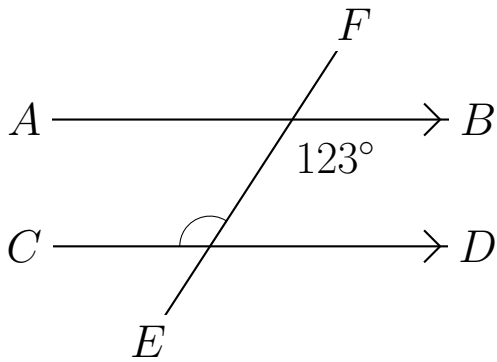
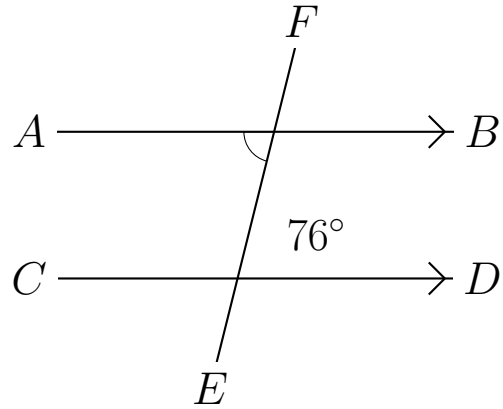
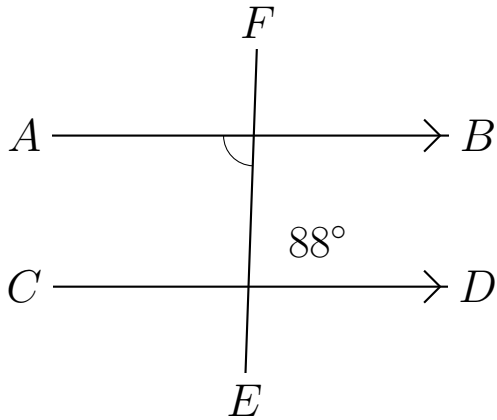

Alternate Angles (I) Answers

Find the alternate angle measurements for the measured angles.

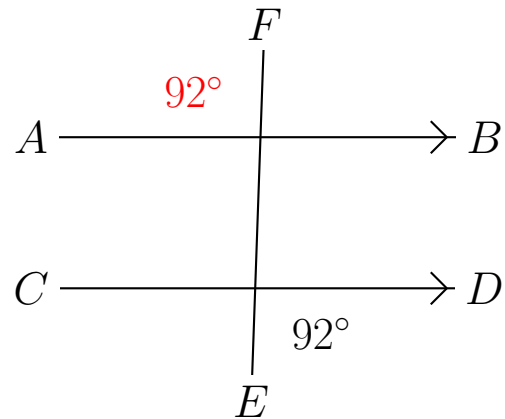
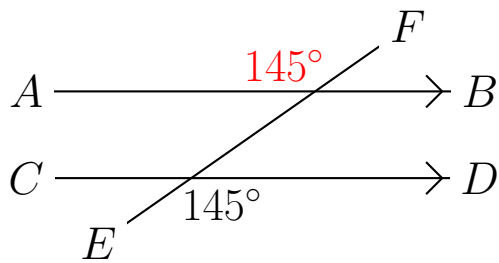
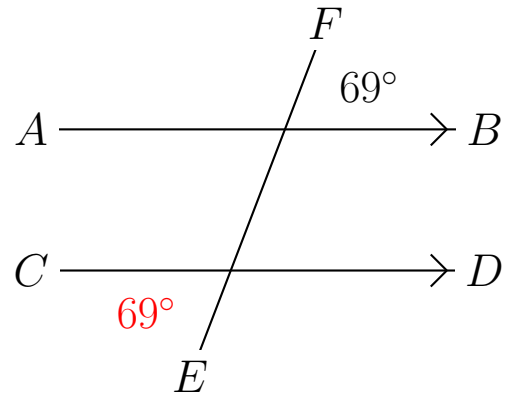
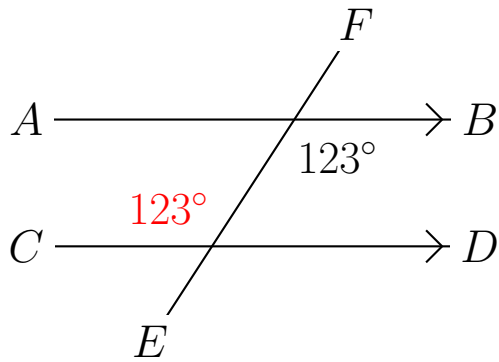
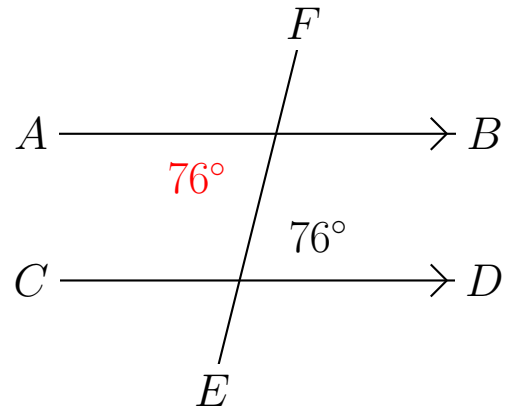
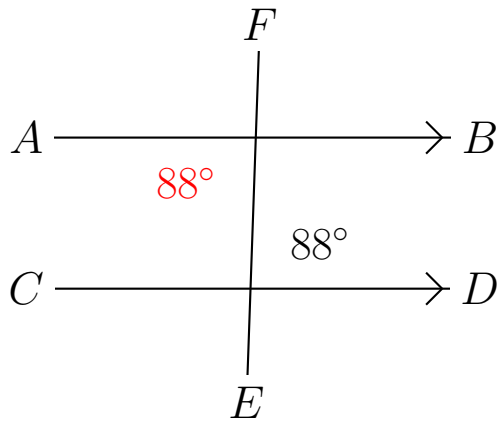

Alternate Angles (J)

Find the alternate angle measurements for the measured angles.

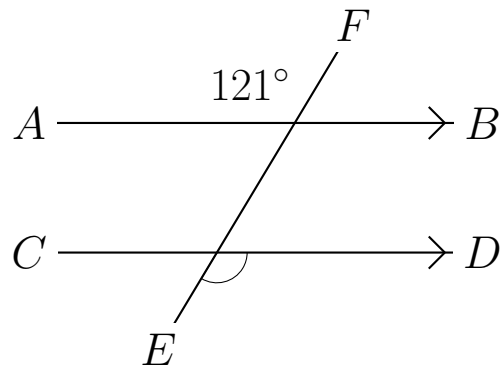
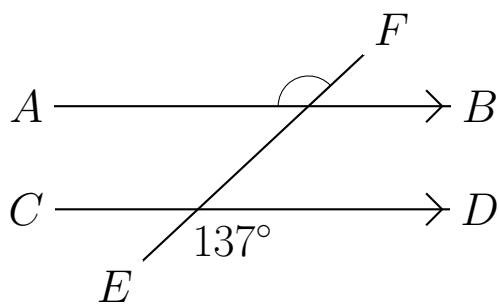
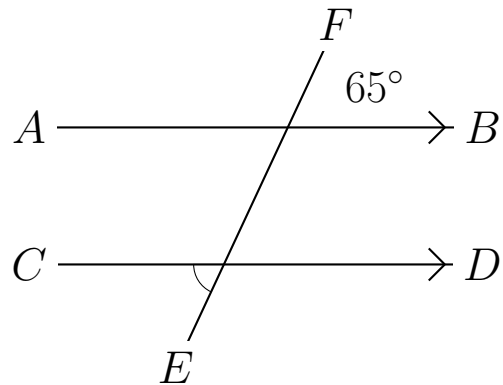
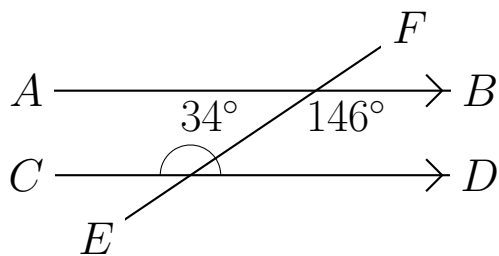
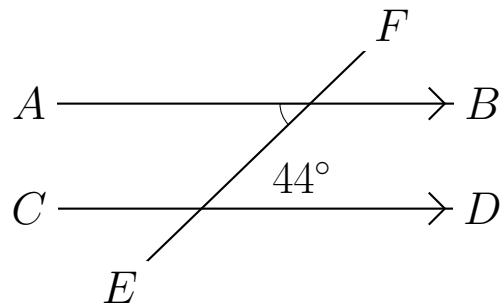
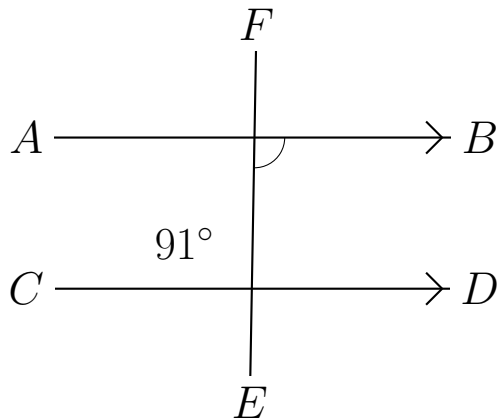

Alternate Angles (J) Answers

Find the alternate angle measurements for the measured angles.

